

DRE

door catalogue

2023

edition 1



DRE Estrá 5 door
white matt

On promotion

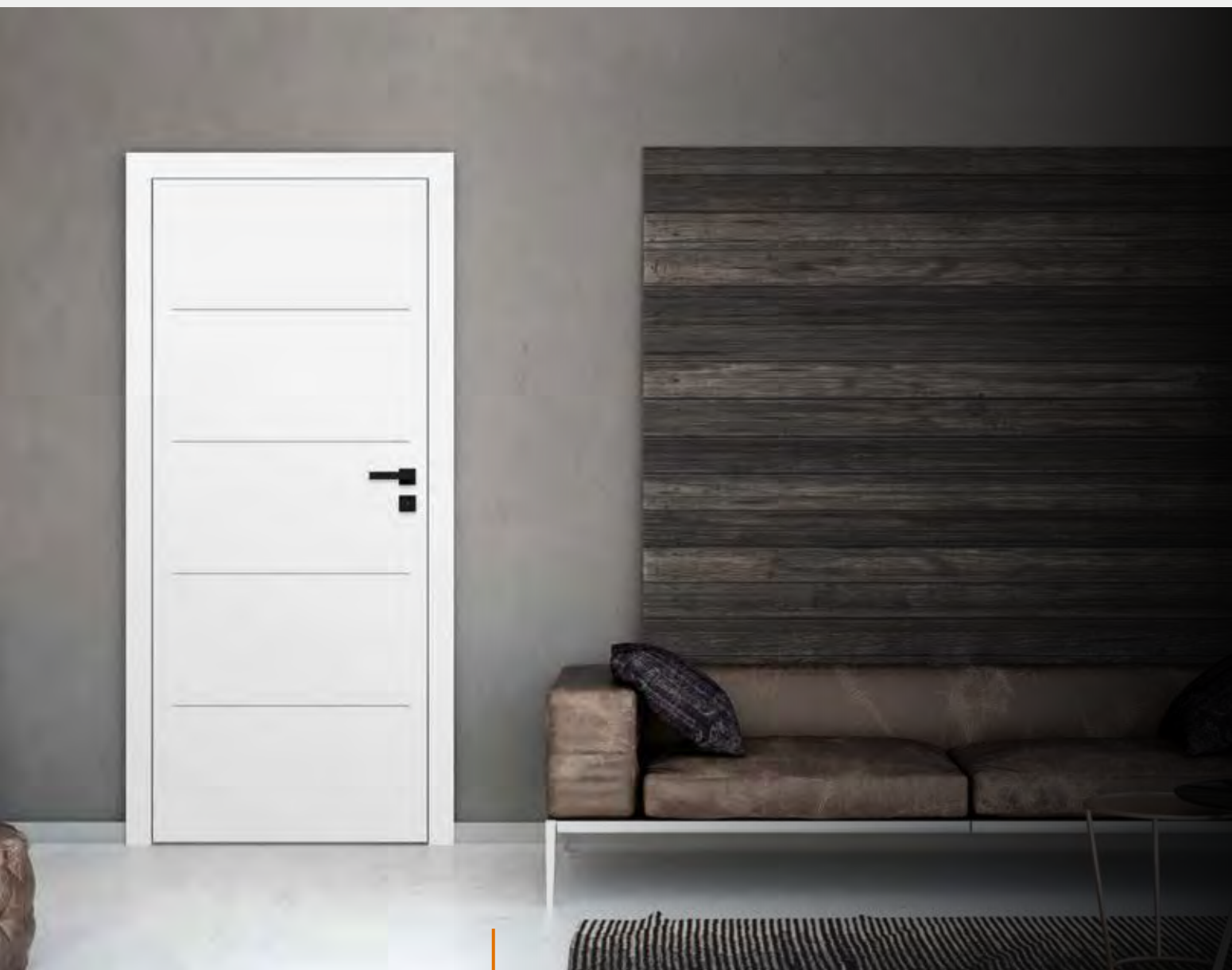

BINITO 20



The door is painted with the highest quality acrylic UV varnish, which protects the leaf surface for a long time.

* Note: selected configurations of BINITO 20 model are available as stock orders, rebated in white matt.

** Promotion of the BINITO collection with WEGA handle with backplate while stocks last.

TABLE OF CONTENTS

FRAME CONSTRUCTION DOORS

NEW	Vetro E-Synchro.....	4
NEW	Sigma.....	6
	Estra.....	8
	Verano.....	10
	Ena.....	11
	Triesta.....	12
	Solte.....	13
	Reva.....	14
	Fosca.....	16
	Nestor.....	18
	Auri.....	20
	Elsa.....	22
	Premium.....	24
	Piano.....	26
	Scala.....	28
	Verso.....	30
	Vetro A.....	32
	Vetro B.....	34
	Vetro D.....	36

FRAME CONSTRUCTION DOORS PAINTED

Berge.....	38
Even.....	40
Nestor.....	42
Vetro E.....	44

PANEL CONSTRUCTION DOORS

Nova -Cell.....	46
Wood.....	48
Claro.....	50
Grafi.....	52
Lux.....	56
Nova -Synchro.....	58
Rivia.....	60
Galeria Alu.....	62
Arte B.....	64
Carla.....	66
Finea and Finea B.....	68
Deco.....	70
Modern.....	72
Kanon.....	74
Plus.....	76
Standard.....	78
Fano.....	80
Arte.....	82

PANEL DOORS PAINTED

UNI.....	84
Fargo.....	86
BINITO.....	88

PANEL CONSTRUCTION DOORS CPL LAMINATE

Standard Invest.....	90
Standard CPL.....	92

PANEL DOORS WITH VARIABLE HEIGHTS

Standard 10.....	93
Modern.....	94
Plus.....	95

SLIDING SYSTEM

Wall mounted sliding system.....	96
Glass doors sliding system.....	98
Wall-mounted sliding system SPAZIO CD.....	100
Cassette tunnel cover PA.....	102

FOLDING DOORS

Folde.....	104
------------	-----

DOORS WITH HIDDEN DOOR FRAME

SARA ECO 2.....	106-108
DRE aluminum door frames.....	109

SIDE PANELS

Panel construction.....	110
Frame construction.....	111

TRANSOM LIGHTS AND SIDELIGHTS

TRANSOM LIGHTS AND SIDELIGHTS.....	112
------------------------------------	-----

INETRIOR ENTRANCE PANEL CONSTRUCTION DOOR LEAVES

Enter/Solid.....	114
SOLID RC2.....	118

TECHNICAL DOOR LEAVES

Athos fire resistant door leaves EI30.....	120
FORCA anti-burglary door leaves RC3, fire resistant.....	122
Forca B RC3 anti-burglary door leaves.....	123
Fire resistant door leaves OLIMP EI30 EI 60.....	124-125
Metal fire resistant door frame.....	126
Wooden fire resistant door frame.....	127

DOOR LEAVES WITH SOUND INSULATION RATE

Enter Acoustic Rw=32dB.....	128
-----------------------------	-----

GLASS DOORS

Galla.....	129
HARDWARE FOR GLASS DOORS.....	130
Glass doors technical informations.....	131

DOOR FRAMES

Fixed rebated door frames.....	132
Fixed non-rebated door frames.....	133
NEW Adjustable door frames.....	134
Adjustable door frames with variable heights.....	135
NEW Adjustable non-rebated door frames.....	136
Adjustable non-rebated door frames with variable heights.....	137
Adjustable door frames with inverted rebate.....	138
Adjustable tunnel.....	139
Adjustable non-rebated door frames with architrave panels.....	140
Extension panel.....	142
Metal fixed door frame.....	144
Adjustable metal door frame.....	146
Adjustable metal door frame non-rebated.....	148
Hybrid metal door frame.....	149
Hybrid metal door frame non-rebated.....	151
Small angular steel frames.....	152

ACCESSORIES, ADDITIONAL INFORMATIONS

Door handles and accessories.....	153
Veneer colours.....	160
Graphic patterns in GRAFI collection.....	162
Glass panes patterns.....	166
Architraves and skirting boards.....	168
Ventilation accessories and other.....	169
Technical informations.....	170-178



VETRO E - natural halifax oak

EGGER 3 mm
laminates
group 1



CLEAF 4 mm
laminates
group 2



Horizontal cross-section of VETRO E door leaf

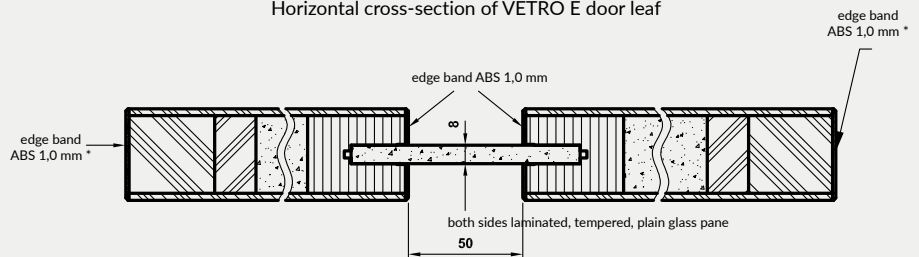

STANDARD OPTIONS

- » door leaf surface is coated with laminated, synchronous 3 mm or 4 mm thick board
- » reinforced MDF frame
- » core made of tubular chipboard
- » DECORMAT tempered laminated 8 mm glass pane with fixed width (regardless the width of the door leaf) or laminated black tempered 8 mm glass pane (opaque) with fixed width (regardless the door leaf width)

NON-REBATED DOOR LEAF

- » edge without rebate in black colour
- » sockets for 2 hidden recessed Estetic 80 hinges in black colour (non-rebated door frames are equipped with hinges)
- » magnetic simple key lock, bathroom lock, cylinder insert lock or economic magnetic lock in black colour

DOOR FRAMES

- » for door leaves from Vetro E collection in synchronous laminates, we recommend door frames finished in black matt colour

NOTE: There is no possibility to shorten door leaf.
VETRO E - widths „80” - „100” with ventilation undercut fulfill ventilation requirements.

OPTIONS AVAILABLE WITH EXTRA CHARGE

- » ventilation undercut

NOTE: third hinge Estetic 80 for non-rebated doors (extra charge is added to the price of the door frame)

fig. 1

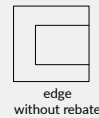

ventilation undercut

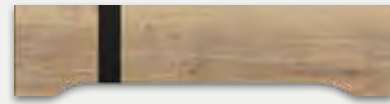



SIGMA 4 - White

Decor
Laminated

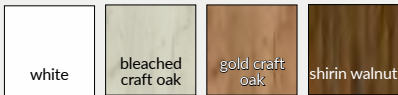

**BEST
PRICE**

STANDARD OPTIONS

- » stiles made of wood-based panels
- » 4mm flat HDF panel black lacquered high gloss

OPTIONS WITHOUT EXTRA CHARGE

- » T2 ventilation sleeves

NON-REBATED HINGED DOOR LEAF

- » edge without rebate **fig.1**
- » sockets for two plate hinges (hinges constitute integral part of the door frame)
- » magnetic simple key lock, bathroom lock, cylinder lock, economic lock
- » ash color non-rebated edge for white decor, non-rebated edge in the same color as door leaf color for other decors
- » alternatively, black non-rebated edge for all decors
- » hinges and locks colors: black, white, steel
- » door leaf in white decor or bleached craft oak is available with Finish foil door frame in the same decor as the door leaf, door leaf in other decors is available with black matt 2 decor door frame.

OPTIONS AVAILABLE WITH EXTRA CHARGE

- » door leaf "90" and "100"
- » ventilation undercut
- » cover strip for double leaf non-rebated door
- » double leaf door leaf price x2
- » **NOTE: third plate hinge for non-rebated doors (extra charge is added to the price of the door frame)**

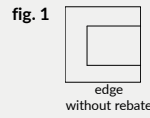
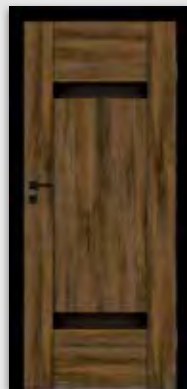

plate hinge



SIGMA 1



SIGMA 2



SIGMA 3



SIGMA 4



ESTRA 8 - black matt 2

Decor
DRE-Cell

white matt	light gray matt	dark olive matt	dark blue matt	black matt 2
------------	-----------------	-----------------	----------------	--------------

Decor 3D

grand oak	elm	american walnut	ebony*	Polish oak 3D
-----------	-----	-----------------	--------	---------------

*while stock last

STANDARD OPTIONS

- » stiles made of wood-based panels
- » glass pane MAT DRE 4 mm thick
- » 16mm flat panels
- » Estra 7-9 models have black glass pane frame and black muntin frame

OPTIONS WITHOUT EXTRA CHARGE

- » glass pane DECORMAT BROWN, DECORMAT GRAPHITE and transparent glass pane
- » holes for ventilation sleeves

REBATED DOOR LEAF

- » straight edge **fig. 1**
- » 3 silver screw-in pivot hinges
- » single-point mortise simple key lock, for bathroom lock, for cylinder lock or economic lock

NON-REBATED HINGED DOOR LEAF (EXTRA CHARGE)

- » edge without rebate **fig. 2**
- » sockets for 2 hidden recessed Estetic 80 hinges (hinges constitute a part of the door frame)
- » magnetic simple key lock, bathroom lock, cylinder lock, economic lock

SLIDING DOOR LEAF

- » edge without rebate **fig. 2**
- » socket for hook lock and/or for handles

NOTE: It is required to use door frame equipped with 3 hinges with ESTRA rebated door leaf .

OPTIONS AVAILABLE WITH EXTRA CHARGE

- » plastic ventilation sleeves 1 pc.
- » non-rebated door leaf
- » door leaf "90" and "100"
- » ventilation undercut
- » cover strip for double leaf non-rebated door
- » double leaf door leaf price x2
- » NOTE: third Estetic 80 hinge for non-rebated doors (extra charge is added to the price of the door frame)

fig. 1

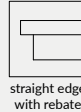
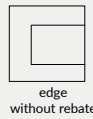

fig. 2



NEW MODELS

STANDARD OPTIONS

- » stiles made of wood-based panels
- » glass pane MAT DRE 4 mm thick

OPTIONS WITHOUT EXTRA CHARGE

- » glass pane DECORMAT BROWN, DECORMAT GRAPHITE and transparent glass pane
- » holes for ventilation sleeves

OPTIONS AVAILABLE WITH EXTRA CHARGE

- » plastic ventilation sleeves 1 pc.
- » non-rebated door leaf
- » door leaf "90" and "100"
- » ventilation undercut
- » cover strip for double leaf non-rebated door
- » double leaf door leaf price x2
- » **NOTE:** third Estetic 80 hinge for non-rebated doors (extra charge is added to the price of the door frame)

REBATED DOOR LEAF

- » straight edge **fig. 1**
- » 3 silver screw-in pivot hinges
- » single-point mortise simple key lock, for bathroom lock, for cylinder lock or economic lock

NON-REBATED DOOR LEAF (extra charge)

- » edge without rebate **fig. 2**
- » sockets for 2 hidden recessed Estetic 80 hinges (hinges constitute a part of the door frame)
- » magnetic simple key lock, bathroom lock, cylinder lock, economic lock

SLIDING DOOR LEAF

- » edge without rebate **fig. 2**
- » socket for hook lock and/or for handles

NOTE: It is required to use door frame equipped with 3 hinges with VERANO rebated door leaf.

fig. 1

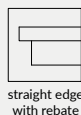
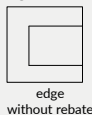
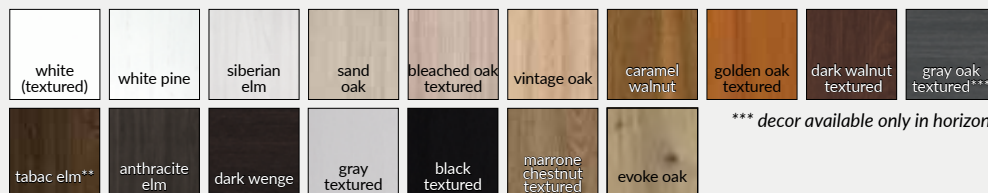

fig. 2



Decor DRE-Cell



STANDARD OPTIONS

- » stiles made of wood-based panels
- » glass pane MAT DRE 4 mm thick

OPTIONS WITHOUT EXTRA CHARGE

- » glass pane DECORMAT BROWN, DECORMAT GRAPHITE and transparent glass pane
- » holes for ventilation sleeves

OPTIONS AVAILABLE WITH EXTRA CHARGE

- » plastic ventilation sleeves 1 pc.
- » non-rebated door leaf
- » door leaf "90" and "100"
- » ventilation undercut
- » cover strip for double leaf non-rebated door
- » double leaf door leaf price x2
- » **NOTE:** third Estetic 80 hinge for non-rebated doors (extra charge is added to the price of the door frame)

REBATED DOOR LEAF

- » straight edge **fig. 1**
- » 3 silver screw-in pivot hinges
- » single-point mortise simple key lock, for bathroom lock, for cylinder lock or economic lock

NON-REBATED DOOR LEAF (extra charge)

- » edge without rebate **fig. 2**
- » sockets for 2 hidden recessed Estetic 80 hinges (hinges constitute a part of the door frame)
- » magnetic simple key lock, bathroom lock, cylinder lock, economic lock

SLIDING DOOR LEAF

- » edge without rebate **fig. 2**
- » socket for hook lock and/or for handles

fig. 1

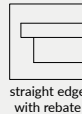
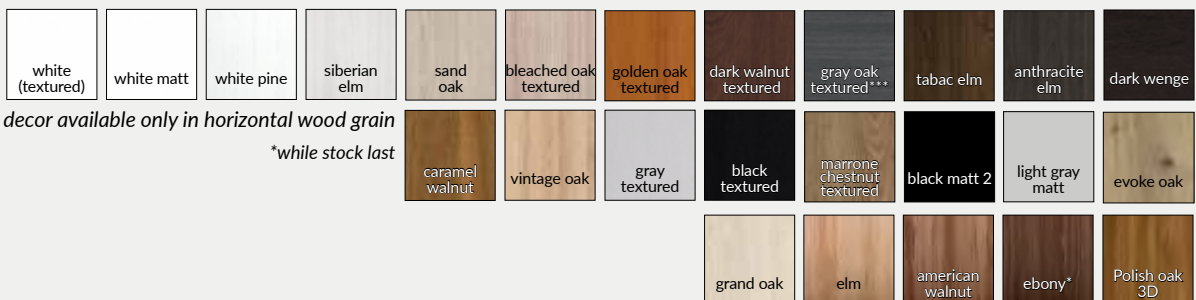
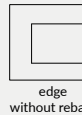

fig. 2



STANDARD OPTIONS

- » stiles made of wood-based panels
- » glass pane MAT DRE 4 mm thick

OPTIONS WITHOUT EXTRA CHARGE

- » glass pane DECORMAT BROWN, DECORMAT GRAPHITE and transparent glass pane
- » holes for ventilation sleeves

OPTIONS AVAILABLE WITH EXTRA CHARGE

- » plastic ventilation sleeves 1 pc.
- » non-rebated door leaf
- » door leaf "90" and "100"
- » ventilation undercut
- » cover strip for double leaf non-rebated door
- » double leaf door leaf price x2
- » **NOTE:** third Estetic 80 hinge for non-rebated doors (extra charge is added to the price of the door frame)

REBATED DOOR LEAF

- » straight edge **fig. 1**
- » 3 silver screw-in pivot hinges
- » single-point mortise simple key lock, for bathroom lock, for cylinder lock or economic lock

NON-REBATED DOOR LEAF (extra charge)

- » edge without rebate **fig. 2**
- » sockets for 2 hidden recessed Estetic 80 hinges (hinges constitute a part of the door frame)
- » magnetic simple key lock, bathroom lock, cylinder lock, economic lock

SLIDING DOOR LEAF

- » edge without rebate **fig. 2**
- » socket for hook lock and/or for handles

NOTE: It is required to use door frame equipped with 3 hinges with TRIESTA rebated door leaf. Left door unit is mirror reflection of the right door leaf unit.

fig. 1



straight edge with rebate

fig. 2



edge without rebate



TRIESTA 0



TRIESTA 1



TRIESTA 2



TRIESTA 3

Decor DRE-Cell

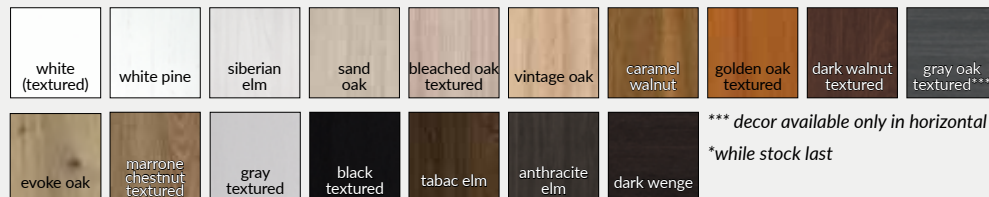

STANDARD OPTIONS

- » stiles made of wood-based panels
- » glass pane MAT DRE 4 mm thick (SOLTE 2 - 3)
- » flat panel insert (SOLTE 1 - 2)

OPTIONS WITHOUT EXTRA CHARGE

- » glass pane DECORMAT BROWN, DECORMAT GRAPHITE and transparent glass pane
- » holes for ventilation sleeves

OPTIONS AVAILABLE WITH EXTRA CHARGE

- » plastic ventilation sleeves 1 pc.
- » non-rebated door leaf
- » door leaf „90” and „100”
- » ventilation undercut
- » cover strip for double leaf non-rebated door
- » double leaf door leaf price x2
- » **NOTE:** third Estetic 80 hinge for non-rebated doors (extra charge is added to the price of the door frame)

REBATED DOOR LEAF

- » straight edge **fig. 1**
- » 3 silver screw-in pivot hinges
- » single-point mortise simple key lock, for bathroom lock, for cylinder lock or economic lock

NON-REBATED DOOR LEAF (extra charge)

- » edge without rebate **fig. 2**
- » sockets for 2 hidden recessed Estetic 80 hinges (hinges constitute a part of the door frame)
- » magnetic simple key lock, bathroom lock, cylinder lock, economic lock

SLIDING DOOR LEAF

- » edge without rebate **fig. 2**
- » socket for hook lock and/or for handles

NOTE: Rebated „40” side panels available.

NOTE: It is required to use door frame equipped with 3 hinges with SOLTE rebated door leaf.

fig. 1

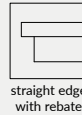
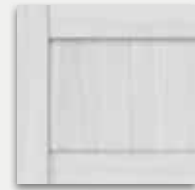
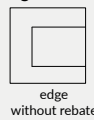

fig. 2



SOLTE panel - 4 mm thick



SOLTE 1

SOLTE 2

SOLTE 3

white (textured)	white matt	white pine	siberian elm	sand oak	bleached oak textured	vintage oak	caramel walnut	golden oak textured	dark walnut textured	gray oak textured***	tabac elm	Decor DRE-Cell
			*** decor available only in horizontal wood grain		anthracite elm	dark wenge	gray textured	black textured	marrone chestnut textured	black matt 2	light gray matt	
			*while stock last									Decor 3D
					grand oak	elm	american walnut	ebony*	Polish oak 3D			



REVA 1 - Siberian elm

Decor DRE-Cell	white (textured)	white matt	white pine	siberian elm	sand oak	bleached oak textured	vintage oak	caramel walnut	golden oak textured	dark walnut textured	gray oak textured***
	anthracite elm	dark wenge	gray textured	black textured	marrone chestnut textured	black matt 2	light gray matt	evoked oak	*** decor available only in horizontal wood grain *while stock last		
Decor 3D	grand oak	elm	american walnut	ebony*	Polish oak 3D						

STANDARD OPTIONS

- » stiles made of wood-based panels
- » glass pane MAT DRE 4 mm thick
- » flat inserts (REVA 5-7)

OPTIONS WITHOUT EXTRA CHARGE

- » glass pane DECORMAT BROWN, DECORMAT GRAPHITE and transparent glass pane
- » holes for ventilation sleeves

REBATED DOOR LEAF

- » straight edge **fig. 1**
- » 3 silver screw-in pivot hinges
- » single-point mortise simple key lock, for bathroom lock, for cylinder lock or economic lock

NON-REBATED DOOR LEAF (extra charge)

- » edge without rebate **fig. 2**
- » sockets for 2 hidden recessed Estetic 80 hinges (hinges constitute a part of the door frame)
- » magnetic simple key lock, bathroom lock, cylinder lock, economic lock

SLIDING DOOR LEAF

- » edge without rebate **fig. 2**
- » socket for hook lock and/or for handles

NOTE: Rebated „40” side panels available.

NOTE: It is required to use door frame equipped with 3 hinges with REVA rebated door leaf.

OPTIONS AVAILABLE WITH EXTRA CHARGE

- » plastic ventilation sleeves 1 pc.
- » non-rebated door leaf
- » door leaf "90" and "100"
- » ventilation undercut
- » cover strip for double leaf non-rebated door
- » black VSG 22,1 safe, complex glass pane REVA 1 **NEW**
- REVA 2
- REVA 3,4
- REVA 5
- REVA 7
- » double leaf door leaf price x2
- » **NOTE:** third Estetic 80 hinge for non-rebated doors (extra charge is added to the price of the door frame)

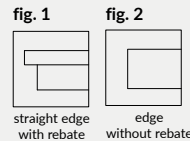



Fosca 3 - dark walnut textured

Decor DRE-Cell	white (textured)	white matt	white pine	siberian elm	sand oak	bleached oak textured	vintage oak	caramel walnut	golden oak textured	dark walnut textured	gray oak textured***	tabac elm
	anthracite elm	dark wenge	gray textured	black textured	marrone chestnut textured	black matt 2	light gray matt	evoked oak	*** decor available only in horizontal wood grain *while stock last			
Decor 3D	grand oak	elm	american walnut	ebony*	Polish oak 3D							

STANDARD OPTIONS

- » stiles made of wood-based panels
- » glass pane MAT DRE 4 mm thick
- » flat panel insert coated with silver laminate (FOSCA 1-3) or in door leaf colour (FOSCA 4-6)

OPTION WITHOUT EXTRA CHARGE

- » glass pane DECORMAT BROWN, DECORMAT GRAPHITE and transparent glass pane
- » holes for ventilation sleeves

OPTIONS AVAILABLE WITH EXTRA CHARGE

- » plastic ventilation sleeves 1 pc.
- » non-rebated door leaf
- » door leaf „90” and „100”
- » ventilation undercut
- » cover strip for double leaf non-rebated door
- » double leaf door leaf price x2
- » **NOTE:** third Estetic 80 hinge for non-rebated doors (extra charge is added to the price of the door frame)

REBATED DOOR LEAF

- » straight edge **fig. 1**
- » 3 silver screw-in pivot hinges
- » single-point mortise simple key lock, for bathroom lock, for cylinder lock or economic lock

NON-REBATED DOOR LEAF (extra charge)

- » edge without rebate **fig. 2**
- » sockets for 2 hidden recessed Estetic 80 hinges (hinges constitute a part of the door frame)
- » magnetic simple key lock, bathroom lock, cylinder lock, economic lock

SLIDING SYSTEM DOOR LEAF

- » edge without rebate **fig. 2**
- » socket for hook lock and/or for handles

NOTE: Rebated „40” side panels available.

NOTE: It is required to use door frame equipped with 3 hinges with FOSCA rebated door leaf.

fig. 1



straight edge
with rebate

fig. 2



edge
without rebate



FOSCA 1-3
(4mm HDF insert
coated with silver
laminate)

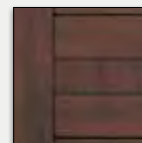

FOSCA 4-6
(4mm HDF
insert coated in
door leaf colour)

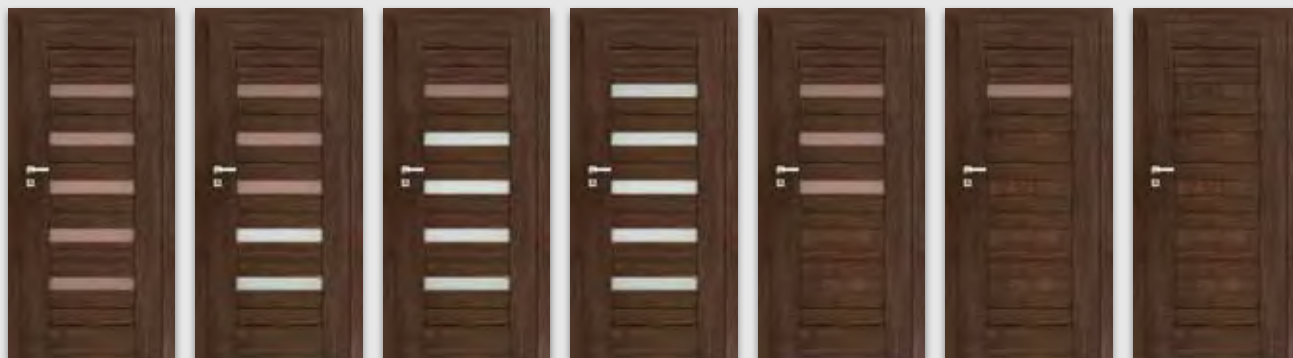

FOSCA 0
(5 glass panes)

FOSCA 1
(3 glass panes, 2 HDF
panels)

FOSCA 2
(1 glass pane, 4 HDF
panels)

FOSCA 3
(5 HDF panels)

FOSCA 4
(3 glass panes, 2 HDF
panels)

FOSCA 5
(1 glass pane, 4 HDF
panels)

FOSCA 6
(5 HDF panels)



NESTOR 10 white pine

Decor DRE-Cell						
	white matt	white pine	sand oak	vintage oak	anthracite elm	dark wenge
Decor 3D						
	Polish oak 3D					

WEGA DOOR HANDLE WITH A BACKPLATE

(available only with rebated and non-rebated door leaf
in NESTOR and ELSA collections in DRE-CELL and 3D decor)
finish color black matt



STANDARD OPTIONS

- » stiles made of wood-based panels
- » glass pane MAT DRE 4 mm thick
- » profiled 19mm MDF panels

OPTIONS WITHOUT EXTRA CHARGE

- » glass pane DECORMAT BROWN, DECORMAT GRAPHITE and transparent glass pane
- » holes for ventilation sleeves

OPTIONS AVAILABLE WITH EXTRA CHARGE

- » plastic ventilation sleeves 1 pc.
- » non-rebated door leaf
- » door leaf „90” and „100”
- » ventilation undercut
- » cover strip for double leaf non-rebated door
- » double leaf door leaf price x2
- » **NOTE:** third Estetic 80 hinge for non-rebated doors (extra charge is added to the price of the door frame)

REBATED DOOR LEAF

- » straight edge **fig. 1**
- » 3 silver screw-in pivot hinges
- » single-point mortise simple key lock, for bathroom lock, for cylinder lock or economic lock

NON-REBATED DOOR LEAF (extra charge)

- » edge without rebate **fig. 2**
- » sockets for 2 hidden recessed Estetic 80 hinges (hinges constitute a part of the door frame)
- » magnetic simple key lock, bathroom lock, cylinder lock, economic lock

SLIDING DOOR LEAF

- » edge without rebate **fig. 2**
- » socket for hook lock and/or for handles

NOTE: It is required to use door frame equipped with 3 hinges with NESTOR rebated door leaf.

fig. 1

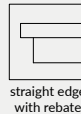
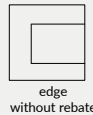

fig. 2





AURI 0 - white matt

Decor DRE-Cell	white (textured)	white matt	white pine	siberian elm	sand oak	bleached oak textured	vintage oak	caramel walnut	golden oak textured	dark walnut textured	gray oak textured***	tabac elm
	anthracite elm	dark wenge	gray textured	black textured	marrone chestnut textured	black matt 2	light gray matt	evoked oak	*** decor available only in horizontal wood grain *while stock last			
Decor 3D	grand oak	elm	american walnut	ebony*	Polish oak 3D							

STANDARD OPTIONS

- » stiles made of wood-based panels
- » glass pane MAT DRE 4 mm thick
- » flat inserts (AURI 6-8)

OPTIONS WITHOUT EXTRA CHARGE

- » glass pane DECORMAT BROWN, DECORMAT GRAPHITE and transparent glass pane
- » holes for ventilation sleeves

REBATED DOOR LEAF

- » straight edge **fig. 1**
- » 3 silver screw-in pivot hinges
- » single-point mortise simple key lock, for bathroom lock, for cylinder lock or economic lock

NON-REBATED DOOR LEAF (extra charge)

- » edge without rebate **fig. 2**
- » sockets for 2 hidden recessed Estetic 80 hinges (hinges constitute a part of the door frame)
- » magnetic simple key lock, bathroom lock, cylinder lock, economic lock

SLIDING DOOR LEAF

- » edge without rebate **fig. 2**
- » socket for hook lock and/or for handles

NOTE: Rebated „40” side panels available.

It is required to use door frame equipped with 3 hinges with AURI rebated door leaf.

OPTIONS AVAILABLE WITH EXTRA CHARGE

- » plastic ventilation sleeves 1 pc.
- » non-rebated door leaf
- » door leaf "90" and "100"
- » ventilation undercut
- » cover strip for double leaf non-rebated door
- » black VSG 22,1 safe, complex glass pane **NEW**
- AURI 0
- AURI 1
- AURI 2, 5
- AURI 3
- AURI 4
- AURI 6
- AURI 8
- » double leaf door leaf price x2
- » **NOTE:** third Estetic 80 hinge for non-rebated doors (extra charge is added to the price of the door frame)

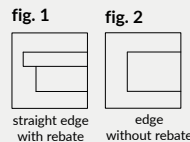



ELSA A3 and ELSA 0 - sand oak



WEGA DOOR HANDLE WITH A BACKPLATE

(available only with rebated and non-rebated door leaf
in NESTOR and ELSA collections in DRE-CELL and 3D decor)
finish color black matt



STANDARD OPTIONS

- » stiles made of wood-based panels
- » glass pane MAT DRE 4 mm thick
- » flat panel insert (ELSA A), profiled 19 mm MDF panels (ELSA B)

OPTIONS WITHOUT EXTRA CHARGE

- » glass pane DECORMAT BROWN, DECORMAT GRAPHITE and transparent glass pane
- » holes for ventilation sleeves

OPTIONS AVAILABLE WITH EXTRA CHARGE

- » plastic ventilation sleeves 1 pc.
- » non-rebated door leaf
- » door leaf "90" and "100"
- » ventilation undercut
- » cover strip for double leaf non-rebated door
- » double leaf door leaf price x2
- » **NOTE:** third Estetic 80 hinge for non-rebated doors (extra charge is added to the price of the door frame)

REBATED DOOR LEAF

- » straight edge **fig. 1**
- » 3 silver screw-in pivot hinges
- » single-point mortise simple key lock, for bathroom lock, for cylinder lock or economic lock

NON-REBATED DOOR LEAF (extra charge)

- » edge without rebate **fig. 2**
- » sockets for 2 hidden recessed Estetic 80 hinges (hinges constitute a part of the door frame)
- » magnetic simple key lock, bathroom lock, cylinder lock, economic lock

SLIDING DOOR LEAF

- » edge without rebate **fig. 2**
- » socket for hook lock and/or for handles

NOTE: Rebated „40" side panels available.

It is required to use door frame equipped with 3 hinges with EMENA rebated door leaf.

ELSA collection is divided into A and B:
A - flat panel insert in door leaf colour
B - 19 mm convex panel insert in door leaf colour

fig. 1



straight edge with rebate

fig. 2



edge without rebate



cross-section of ELSA A



cross-section of ELSA B





Premium 0 with a side panel - vintage oak

Decor DRE-Cell	white (textured)	white matt	white pine	siberian elm	sand oak	bleached oak textured	golden oak textured	dark walnut textured	gray oak textured***	tabac elm	anthracite elm	dark wenge
	evoke oak	light gray matt	black matt 2	marrone chestnut textured	gray textured	black textured	caramel walnut	vintage oak	*** decor available only in horizontal wood grain *while stock last			
Decor 3D	grand oak	elm	american walnut	ebony*	Polish oak 3D							

STANDARD OPTIONS

- » stiles made of wood-based panels
- » glass pane MAT DRE 4 mm thick

OPTION WITHOUT EXTRA CHARGE

- » glass pane DECORMAT BROWN, DECORMAT GRAPHITE and transparent glass pane
- » holes for ventilation sleeves

OPTIONS AVAILABLE WITH EXTRA CHARGE

- » plastic ventilation sleeves 1 pc.
- » non-rebated door leaf
- » door leaf "90" and "100"
- » ventilation undercut
- » cover strip for double leaf non-rebated door
- » double leaf door leaf price x2
- » **NOTE:** third Estetic 80 hinge for non-rebated doors (extra charge is added to the price of the door frame)

REBATED DOOR LEAF

- » straight edge **fig. 1**
- » 3 silver screw-in pivot hinges
- » single-point mortise simple key lock, for bathroom lock, for cylinder lock or economic lock

NON-REBATED DOOR LEAF (extra charge)

- » edge without rebate **fig. 2**
- » sockets for 2 hidden recessed Estetic 80 hinges (hinges constitute a part of the door frame)
- » magnetic simple key lock, bathroom lock, cylinder lock, economic lock

SLIDING SYSTEM DOOR LEAF

- » edge without rebate **fig. 2**
- » socket for hook lock and/or for handles

NOTE: Rebated „40" side panels available.

NOTE: It is required to use door frame equipped with 3 hinges with PREMIUM rebated door leaf.

fig. 1

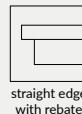
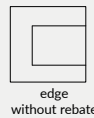

fig. 2



In PREMIUM 12 and 13 models, from the top edge there are used two glass panes.



PREMIUM 0-3
(4 mm glass pane)

* PREMIUM 4-7, 12
(4 mm HDF inserts in door leaf colour)

** PREMIUM 8-11, 13
(4mm HDF inserts, coated with a silver laminate)



PREMIUM 0
PREMIUM 4*
PREMIUM 8**

PREMIUM 1
PREMIUM 5*
PREMIUM 9**

PREMIUM 2
PREMIUM 6*
PREMIUM 10**

PREMIUM 3
PREMIUM 7*
PREMIUM 11**

PREMIUM 12
2 glass panes, 6
inserts in the colour of
the door leaf

PREMIUM 13
2 glass panes, 6
inserts coated with a
silver laminate



PIANO 0 - Polish oak 3D

Decor DRE-Cell	white (textured)	white matt	white pine	siberian elm	sand oak	bleached oak textured	vintage oak	caramel walnut	golden oak textured	dark walnut textured	gray oak textured***	tabac elm
	anthracite elm	dark wenge	gray textured	black textured	marrone chestnut textured	black matt 2	light gray matt	evoke oak	*** decor available only in horizontal wood grain *while stock last			
Decor 3D	grand oak	elm	american walnut	ebony*	Polish oak 3D							

STANDARD OPTIONS

- » stiles made of wood-based panels
- » glass pane MAT DRE 4 mm thick
- » 16 mm convex panel (PIANO 1-2, PIANO 5-6) or 19 mm convex panel (PIANO 9-12)

OPTION WITHOUT EXTRA CHARGE

- » glass pane DECORMAT BROWN, DECORMAT GRAPHITE and transparent glass pane
- » holes for ventilation sleeves

OPTIONS AVAILABLE WITH EXTRA CHARGE

- » plastic ventilation sleeves 1 pc.
- » non-rebated door leaf
- » door leaf "90" and "100"
- » ventilation undercut
- » cover strip for double leaf non-rebated door
- » double leaf door leaf price x2
- » **NOTE:** third Estetic 80 hinge for non-rebated doors (extra charge is added to the price of the door frame)

REBATED DOOR LEAF

- » straight edge **fig. 1**
- » 3 silver screw-in pivot hinges
- » single-point mortise simple key lock, for bathroom lock, for cylinder lock or economic lock

NON-REBATED DOOR LEAF (extra charge)

- » edge without rebate **fig. 2**
- » sockets for 2 hidden recessed Estetic 80 hinges (hinges constitute a part of the door frame)
- » magnetic simple key lock, bathroom lock, cylinder lock, economic lock

SLIDING SYSTEM DOOR LEAF

- » edge without rebate **fig. 2**
- » socket for hook lock and/or for handles

NOTE: Rebated „40" side panels available.

It is required to use door frame equipped with 3 hinges with PIANO rebated door leaf.

fig. 1



straight edge with rebate

fig. 2



edge without rebate

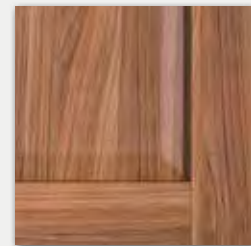

panel PIANO 9-12



PIANO 0

PIANO 1

PIANO 2

PIANO 3

PIANO 4

PIANO 5

PIANO 6



PIANO 9

PIANO 10

PIANO 11

PIANO 12



SCALA 0 - ebony

Decor DRE-Cell	white (textured)	white matt	white pine	siberian elm	sand oak	bleached oak textured	vintage oak	caramel walnut	golden oak textured	dark walnut textured	gray oak textured***	tabac elm
	anthracite elm	dark wenge	gray textured	black textured	marrone chestnut textured	black matt 2	light gray matt	evoke oak	*** decor available only in horizontal wood grain *while stock last			
Decor 3D	grand oak	elm	american walnut	ebony*	Polish oak 3D							

ARCTUS DOOR HANDLE WITH A BACKPLATE

(available only with rebated and non-rebated door leaf in SCALA collection in DRE-Cell laminate and 3D foil)
colour satin nickel



STANDARD OPTIONS

- » stiles made of wood-based panels
- » glass pane MAT DRE 4 mm thick
- » flat panel insert (SCALA A), 19 mm profiled MDF panels (SCALA B)

OPTIONS WITHOUT EXTRA CHARGE

- » glass pane DECORMAT BROWN, DECORMAT GRAPHITE and transparent glass pane
- » holes for ventilation sleeves

OPTIONS AVAILABLE WITH EXTRA CHARGE

- » plastic ventilation sleeves 1 pc.
- » non-rebated door leaf
- » door leaf „90” and „100”
- » ventilation undercut
- » cover strip for double leaf non-rebated door
- » double leaf door leaf price x2
- » **NOTE:** third Estetic 80 hinge for non-rebated doors (extra charge is added to the price of the door frame)

REBATED DOOR LEAF

- » straight edge **fig. 1**
- » 3 silver screw-in pivot hinges
- » single-point mortise simple key lock, for bathroom lock, for cylinder lock or economic lock

NON-REBATED DOOR LEAF (extra charge)

- » edge without rebate **fig. 2**
- » sockets for 2 hidden recessed Estetic 80 hinges (hinges constitute a part of the door frame)
- » magnetic simple key lock, bathroom lock, cylinder lock, economic lock

SLIDING DOOR LEAF

- » edge without rebate **fig. 2**
- » socket for hook lock and/or for handles

NOTE: Rebated „40” side panels available.

It is required to use door frame equipped with 3 hinges with SCALA rebated door leaf.

SCALA collection is divided into A and B:

A - flat panel insert in door leaf colour

B - convex panel insert in door leaf colour

fig. 1



straight edge with rebate

fig. 2



edge without rebate



panel SCALA A, A1-A7

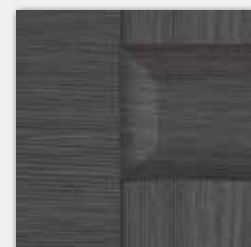

panel SCALA B, B1-B7



SCALA A/B

SCALA A1/B1

SCALA A2/B2

SCALA A3/B3

SCALA A4/B4



SCALA A5/B5

SCALA A6/B6

SCALA A7/B7

SCALA 0



VERSO 0 - white pine

Decor
DRE-Cell



STANDARD OPTIONS

- » stiles made of wood-based panels
- » glass pane MAT DRE 4 mm thick

OPTIONS WITHOUT EXTRA CHARGE

- » glass pane DECORMAT BROWN, DECORMAT GRAPHITE and transparent glass pane
- » holes for ventilation sleeves

OPTIONS AVAILABLE WITH EXTRA CHARGE

- » plastic ventilation sleeves 1 pc.
- » non-rebated door leaf
- » door leaf "90" and "100"
- » ventilation undercut
- » cover strip for double leaf non-rebated door
- » double leaf door leaf price x2
- » **NOTE:** third Estetic 80 hinge for non-rebated doors (extra charge is added to the price of the door frame)

REBATED DOOR LEAF

- » straight edge **fig. 1**
- » 3 silver screw-in pivot hinges
- » single-point mortise simple key lock, for bathroom lock, for cylinder lock or economic lock

NON-REBATED DOOR LEAF (extra charge)

- » edge without rebate **fig. 2**
- » sockets for 2 hidden recessed Estetic 80 hinges (hinges constitute a part of the door frame)
- » magnetic simple key lock, bathroom lock, cylinder lock, economic lock

SLIDING DOOR LEAF

- » edge without rebate **fig. 2**
- » socket for hook lock and/or for handles

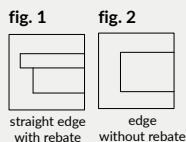

VERSO 0



VERSO 1



VERSO 2



VERSO 3



VERSO 4

* Note: selected configurations of VERSO model are available as stock orders, rebated in white matt.



VETRO A5 white pine

Decor DRE-Cell	white (textured)	white matt	white pine	siberian elm	sand oak	bleached oak textured	vintage oak	caramel walnut	golden oak textured	dark walnut textured	gray oak textured***	tabac elm
	anthracite elm	dark wenge	gray textured	black textured	marrone chestnut textured	black matt 2	light gray matt	evoke oak	toffee oak ***			
Decor 3D	grand oak	elm	american walnut	ebony*	Polish oak 3D	*** decor available only in horizontal wood grain						
						*while stock last						

NOTE: It is possible to order non-rebated door leaf in Dre-Cell white matt colour

cross-section of stile in non-rebated door leaf

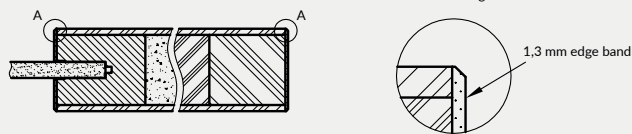

VETRO collection glass panes have obverse and reverse sides (important in combination of two doors opening inversely). Presented horizontal cross-sections shows the arrangement of glass pane in the obverse version. When choosing a reverse version, glass pane is rotated by 180° around the vertical axis.

Horizontal cross-section of door leaf VETRO A1-A4, A12-A15

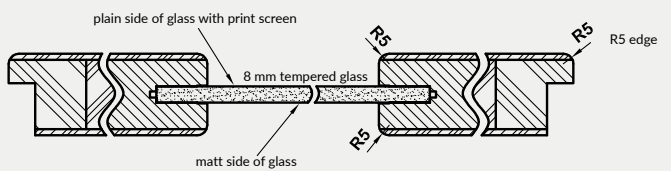

Horizontal cross-section of door leaf VETRO A5, A10 - A11

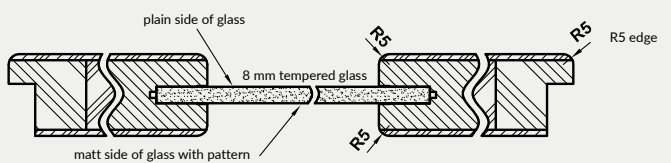

STANDARD OPTIONS

- » reinforced MDF frame
- » core made of tubular chipboard
- » 8 mm tempered glass

OPTIONS WITHOUT EXTRA CHARGE

- » there is possibility to make ventilation undercut (A)
- » door leaf with revers positioning of glass pane
- » VETRO A1 four possible types of glass pane: DECORMAT, DECORMAT BROWN, DECORMAT GRAPHITE and transparent glass

REBATED DOOR LEAF

- » R5 edge **fig. 1**
- » 3 silver screw-in pivot hinges
- » single-point mortise simple key lock, for bathroom lock, for cylinder lock or economic lock

NON-REBATED DOOR LEAF (EXTRA CHARGE)

ONLY WHITE MATT

- » edge without rebate **fig. 2**
- » sockets for 2 hidden recessed Estetic 80 hinges (hinges constitute a part of the door frame)
- » magnetic simple key lock, bathroom lock, cylinder lock, economic lock

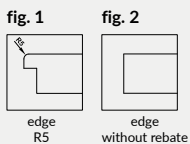

OPTIONS AVAILABLE WITH EXTRA CHARGE - AVAILABLE ONLY IN WHITE MAT DRE-CELL DECOR

- » non-rebated door leaf
- » **NOTE:** third Estetic 80 hinge for non-rebated doors (extra charge is added to the price of the door frame)

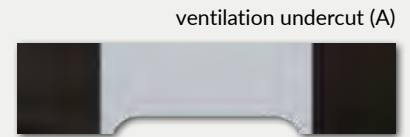

SLIDING DOOR LEAF

- » edge without rebate **fig. 2**
- » socket for hook lock and/or for handles

NOTE: Door leaf VETRO A in sliding version is not complementary product to sliding system hidden in the wall PA.

NOTE: There is no possibility to shorten door leaf.

NOTE: It is required to use door frame equipped with 3 hinges with VETRO rebated door leaf.

VETRO A - „80“-„100“-models with ventilation undercut fulfill ventilation requirements.





VETRO B11 - black structure

Decor DRE-Cell	white (textured)	white matt	white pine	siberian elm	sand oak	bleached oak textured	vintage oak	caramel walnut	golden oak textured	dark walnut textured	gray oak textured***
	tabac elm	anthracite elm	dark wenge	gray textured	black textured	marrone chestnut textured	black matt 2	light gray matt	evoke oak	toffee oak ***	
Decor 3D	grand oak	elm	american walnut	ebony*	Polish oak 3D	*** decor available only in horizontal wood grain					
						*while stock last					

NOTE: It is possible to order non-rebated door leaf in Dre-Cell white matt colour

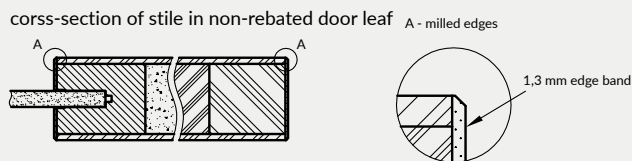

VETRO collection glass panes have obverse and reverse sides (important in combination of two doors opening inversely). Presented horizontal cross-sections shows the arrangement of glass pane in the obverse version. When choosing a reverse version, glass pane is rotated by 180° around the vertical axis.

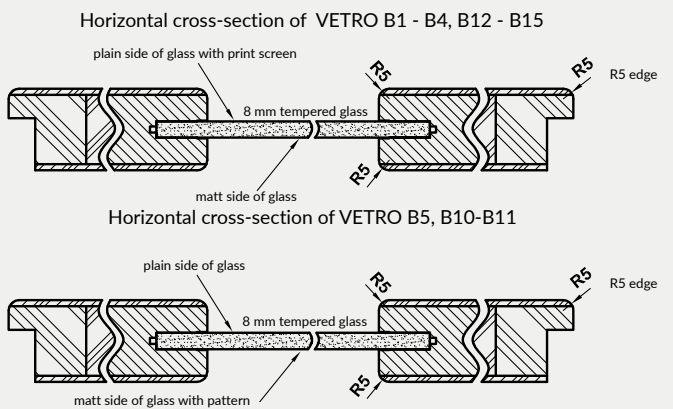

STANDARD OPTIONS

- » reinforced MDF frame
- » core made of tubular chipboard
- » 8 mm tempered glass

OPTIONS WITHOUT EXTRA CHARGE

- » there is possibility to make ventilation undercut (B)
- » VETRO B1 four possible types of glass pane: DECORMAT, DECORMAT BROWN, DECORMAT GRAPHITE and transparent glass
- » door leaf with revers positioning of glass pane

OPTIONS AVAILABLE WITH EXTRA CHARGE - AVAILABLE ONLY IN WHITE MAT DRE-CELL DECOR

- » non-rebated door leaf
- » **NOTE:** third Estetic 80 hinge for non-rebated doors (extra charge is added to the price of the door frame)



VETRO B - doesn't fulfill ventilation requirements

REBATED DOOR LEAF

- » R5 edge **fig. 1**
- » 3 silver screw-in pivot hinges
- » single-point mortise simple key lock, for bathroom lock, for cylinder lock or economic lock

NON-REBATED DOOR LEAF (EXTRA CHARGE)

ONLY WHITE MATT

- » edge without rebate **fig. 2**
- » sockets for 2 hidden recessed Estetic 80 hinges (hinges constitute a part of the door frame)
- » magnetic simple key lock, bathroom lock, cylinder lock, economic lock

SLIDING DOOR LEAF

- » edge without rebate **fig. 2**
- » socket for hook lock and/or for handles

NOTE: Door leaf VETRO B in sliding version with "70" width is not complementary product to sliding system hidden in the wall PA.

NOTE: There is no possibility to shorten door leaf.

NOTE: It is required to use door frame equipped with 3 hinges with VETRO rebated door leaf.

VETRO B - doesn't fulfill ventilation requirements.

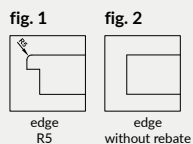



VETRO D1 - anthracite elm

Decor DRE-Cell	white (textured)	white matt	white pine	siberian elm	sand oak	bleached oak textured	vintage oak	caramel walnut	golden oak textured	dark walnut textured	gray oak textured***	tabac elm
	anthracite elm	dark wenge	gray textured	black textured	marrone chestnut textured	black matt 2	light gray matt	evoke oak	toffee oak ***			
Decor 3D	grand oak	elm	american walnut	ebony*	Polish oak 3D	*** decor available only in horizontal wood grain						
						*while stock last						

NOTE: It is possible to order non-rebated door leaf in Dre-Cell white matt colour

VETRO collection glass panes have obverse and reverse sides (important in combination of two doors opening inversely). Presented horizontal cross-sections shows the arrangement of glass pane in the obverse version. When choosing a reverse version, glass pane is rotated by 180° around the vertical axis.

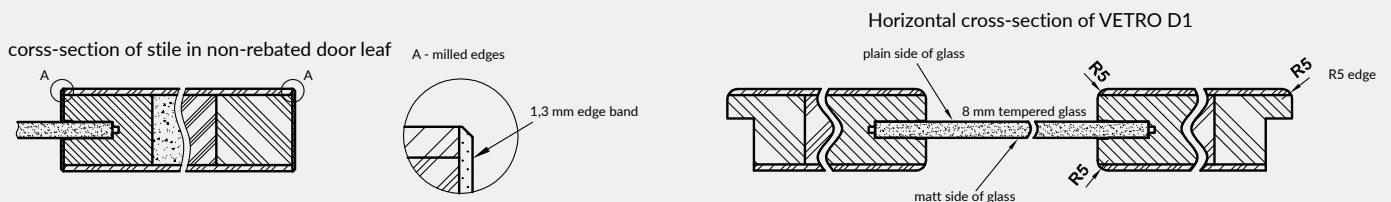

STANDARD OPTIONS

- » reinforced MDF frame: narrow element with fixed width, wide element with variable width
- » core made of tubular chipboard
- » 8 mm tempered glass with fixed width, (regardless of the door leaf width)

OPTIONS WITHOUT EXTRA CHARGE

- » door leaf with revers positioning of glass pane

OPTIONS AVAILABLE WITH EXTRA CHARGE

- » ventilation undercut
- » black tempered laminated glass pane

REBATED DOOR LEAF

- » R5 edge **fig. 1**
- » 3 silver screw-in pivot hinges
- » single-point mortise simple key lock, for bathroom lock, for cylinder lock or economic lock

NON-REBATED DOOR LEAF (EXTRA CHARGE)

ONLY WHITE MATT

- » edge without rebate **fig. 2**
- » sockets for 2 hidden recessed Estetic 80 hinges (hinges constitute a part of the door frame)
- » magnetic simple key lock, bathroom lock, cylinder lock, economic lock

fig. 1



edge
R5

fig. 2



edge
without rebate

OPTIONS AVAILABLE WITH EXTRA CHARGE - AVAILABLE ONLY IN WHITE MAT DRE-CELL DECOR

- » non-rebated door leaf
- » **NOTE:** third Estetic 80 hinge for non-rebated doors (extra charge is added to the price of the door frame)
ventilation undercut



SLIDING DOOR LEAF

- » edge without rebate **fig. 2**
- » socket for hook lock and/or for handles

NOTE: Door leaf VETRO D in sliding version is not complementary product to sliding system hidden in the wall PA.

NOTE: There is no possibility to shorten door leaf.

VETRO D - widths „80” - „100” with ventilation undercut fulfill ventilation requirements.

NOTE: It is required to use door frame equipped with 3 hinges with VETRO rebated door leaf.



VETRO D1
transparent
glass pane

VETRO D1
decormat

VETRO D1
decormat brown

VETRO D1
decormat
graphite



BERGE 6 - white

Decor
painted



white acrylic UV varnish - RAL 9003
ecru - RAL 9001
latte - Flugger 4362, NCS S1505-Y50R
ashen - RAL 7035

STANDARD OPTIONS

- » door leaf painted with acrylic UV varnish
- » stiles made of wood-based panels
- » glass pane MAT DRE 4 mm thick
- » profiled 19mm MDF panels

OPTIONS WITHOUT EXTRA CHARGE

- » glass pane DECORMAT BROWN, DECORMAT GRAPHITE and transparent glass pane
- » holes for ventilation sleeves

OPTIONS AVAILABLE WITH EXTRA CHARGE

- » plastic ventilation sleeves 1 pc.
- » non-rebated door leaf
- » door leaf "90" and "100"
- » ventilation undercut
- » cover strip for double leaf non-rebated door
- » double leaf door leaf price x2
- » **NOTE:** third Estetic 80 hinge for non-rebated doors (extra charge is added to the price of the door frame)

REBATED DOOR LEAF

- » straight edge **fig. 1**
- » 3 silver screw-in pivot hinges
- » single-point mortise simple key lock, for bathroom lock, for cylinder lock or economic lock

NON-REBATED DOOR LEAF (extra charge)

- » edge without rebate **fig. 2**
- » sockets for 2 hidden recessed Estetic 80 hinges (hinges constitute a part of the door frame)
- » magnetic simple key lock, bathroom lock, cylinder insert lock or economic magnetic lock in steel, black or white colour

SLIDING DOOR LEAF

- » edge without rebate **fig. 2**
- » socket for hook lock and/or for handles

NOTE: It is required to use door frame equipped with 3 hinges with BERGE rebated door leaf.

fig. 1

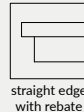
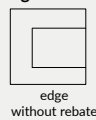

fig. 2



To ensure the highest quality of painted products, before painting process, both, door leaf and door frames are coated with special material which constitutes solid base.





EVEN 0 - ashen

Decor
painted



white acrylic UV varnish - RAL 9003
 ecru - RAL 9001
 latte - Flugger 4362, NCS S1505-Y50R
 ashen - RAL 7035

STANDARD OPTIONS

- » door leaf painted with acrylic UV varnish
- » stiles made of wood-based panels
- » glass pane MAT DRE 4 mm thick

OPTIONS WITHOUT EXTRA CHARGE

- » glass pane DECORMAT BROWN, DECORMAT GRAPHITE and transparent glass pane
- » holes for ventilation sleeves

OPTIONS AVAILABLE WITH EXTRA CHARGE

- » plastic ventilation sleeves 1 pc.
- » non-rebated door leaf
- » door leaf "90" and "100"
- » ventilation undercut
- » cover strip for double leaf non-rebated door
- » double leaf door leaf price x2
- » **NOTE:** third Estetic 80 hinge for non-rebated doors (extra charge is added to the price of the door frame)

REBATED DOOR LEAF

- » straight edge **fig. 1**
- » 3 silver screw-in pivot hinges
- » single-point mortise simple key lock, for bathroom lock, for cylinder lock or economic lock

NON-REBATED DOOR LEAF (extra charge)

- » edge without rebate **fig. 2**
- » sockets for 2 hidden recessed Estetic 80 hinges (hinges constitute a part of the door frame)
- » magnetic simple key lock, bathroom lock, cylinder insert lock or economic magnetic lock in steel, black or white colour

SLIDING DOOR LEAF

- » edge without rebate **fig. 2**
- » socket for hook lock and/or for handles

NOTE: It is required to use door frame equipped with 3 hinges with **EVEN** rebated door leaf.

fig. 1

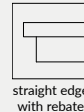
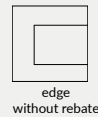

fig. 2



To ensure the highest quality of painted products, before painting process, both, door leaf and door frames are coated with special material which constitutes solid base.





NESTOR 3 - ashen

Decor
painted



white acrylic UV varnish - RAL 9003
 ecru - RAL 9001
 latte - Flügger 4362, NCS S1505-Y50R
 ashen - RAL 7035

STANDARD OPTIONS

- » door leaf painted with acrylic UV varnish
- » stiles made of wood-based panels
- » glass pane MAT DRE 4 mm thick
- » profiled 19mm MDF panels

OPTIONS WITHOUT EXTRA CHARGE

- » glass pane DECORMAT BROWN, DECORMAT GRAPHITE and transparent glass pane
- » holes for ventilation sleeves

REBATED DOOR LEAF

- » straight edge **fig. 1**
- » 3 silver screw-in pivot hinges
- » single-point mortise simple key lock, for bathroom lock, for cylinder lock or economic lock

NON-REBATED DOOR LEAF (extra charge)

- » edge without rebate **fig. 2**
- » sockets for 2 hidden recessed Estetic 80 hinges (hinges constitute a part of the door frame)
- » magnetic simple key lock, bathroom lock, cylinder insert lock or economic magnetic lock in steel, black or white colour

SLIDING DOOR LEAF

- » edge without rebate **fig. 2**
- » socket for hook lock and/or for handles

NOTE: It is required to use door frame equipped with 3 hinges with NESTOR rebated door leaf.

OPTIONS AVAILABLE WITH EXTRA CHARGE

- » plastic ventilation sleeves 1 pc.
- » non-rebated door leaf
- » door leaf „90” and „100”
- » ventilation undercut
- » cover strip for double leaf non-rebated door
- » double leaf door leaf price x2
- » **NOTE:** third Estetic 80 hinge for non-rebated doors (extra charge is added to the price of the door frame)

fig. 1



straight edge
with rebate

fig. 2



edge
without rebate



NESTOR
panel

To ensure the highest quality of painted products, before painting process, both, door leaf and door frames are coated with special material which constitutes solid base.



NESTOR 1



NESTOR 2



NESTOR 3



NESTOR 4



NESTOR 5



NESTOR 6



NESTOR 10



NESTOR 11



VETRO E - ashen

Decor painted



white acrylic UV varnish - RAL 9003
 ecru - RAL 9001
 latte - Flugger 4362, NCS S1505-Y50R
 ashen - RAL 7035

Horizontal cross-section of VETRO E door leaf

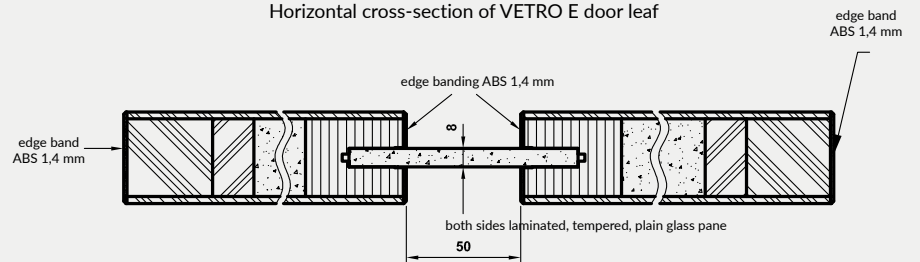

STANDARD OPTIONS

- » door leaf painted with acrylic UV varnish
- » reinforced MDF frame: narrow element with fixed width, wide element with variable width
- » core made of tubular chipboard
- » DECORMAT tempered laminated 8 mm glass pane with fixed width (regardless the width of the door leaf) or laminated black tempered 8 mm glass pane (opaque) with fixed width (regardless the door leaf width)

NON-REBATED DOOR LEAF

- » edge without rebate **fig.1**
- » sockets for 2 hidden recessed Estetic 80 hinges (hinges constitute a part of the door frame)
- » magnetic simple key lock, bathroom lock, cylinder insert lock or economic magnetic lock in steel, black or white colour

NOTE: There is no possibility to shorten door leaf.
VETRO E - widths „80” - „100” with ventilation undercut fulfill ventilation requirements.

To ensure the highest quality of painted products, before painting process, both, door leaf and door frames are coated with special material which constitutes solid base.

OPTIONS AVAILABLE WITH EXTRA CHARGE

- » **NOTE:** third Estetic 80 hinge for non-rebated doors (extra charge is added to the price of the door frame)
- » ventilation undercut

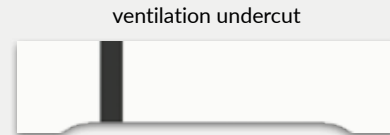

fig. 1



edge
without rebate



VETRO E
white
(black glass pane)



VETRO E
ecru
(black glass pane)



VETRO E
latte
(DECORMAT glass
pane)



VETRO E
ashen
(DECORMAT glass
pane)



NOVA 10 - antique copper

Decor



antique
copper

oxide
concrete

STANDARD OPTIONS

- » door leaf frame made of softwood
- » core made of „honeycomb“
- » glass pane MAT DRE 4 mm thick
- » edgeband in black colour

OPTIONS WITHOUT EXTRA CHARGE

- » ventilation sleeves
- » three hinges - applies to rebated door leaf
- » DECORMAT BROWN, DECORMAT GRAPHITE glass pane and transparent glass

REBATED DOOR LEAF

- » straight edge fig. 1
- » 2 silver screw-in pivot hinges
- » single-point, silver mortise lock for simple key, for bathroom, for cylinder insert or economic lock

NON-REBATED DOOR LEAF (extra charge)

- » edge without rebate fig. 2
- » sockets for 2 hidden recessed Estetic 80 hinges (hinges constitute a part of the door frame)
- » magnetic simple key lock, bathroom lock, cylinder insert lock or economic magnetic lock in black colour

SLIDING DOOR LEAF

- » edge without rebate fig. 2
- » socket for hook lock and/or for handles

DOOR FRAMES

- » for door leaves from NOVA collection it is recommended to use door frames in the same colour as door leaf or in black matt 2 decor

OPTIONS AVAILABLE WITH EXTRA CHARGE

- » core made of tubular chipboard
- » non-rebated door leaf
- » door leaf "90", "100"
- » ventilation undercut
- » plastic ventilation grille
- » aluminum ventilation grille
- » there is possibility to purchase black or stainless steel BULAJ separately
- » **NOTE:** third Estetic 80 hinge for non-rebated doors (extra charge is added to the price of the door frame)

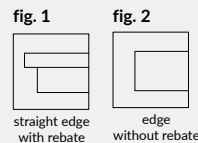

NOVA 10

NOVA 20

NOVA 30

NOVA 40

Possible model options:

M1 - FULL DOOR LEAF, WITHOUT GLAZING

NOVA 20 - MDF bulaj

NOVA 30 - STEEL BULAJ (AVAILABLE ONLY MATT OR TRANSPARENT GLASS PANE)

NOVA 40 - MDF frame in black matt 2 foil

steel BULAJ NOVA 30 - in the steel or black colour. Available only MATT or transparent glass pane.



WOOD M1 design W2 - dark oak

Decor

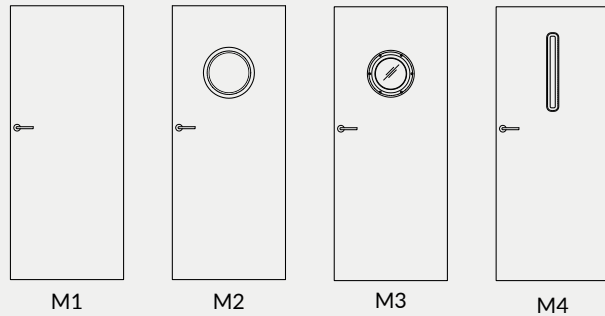
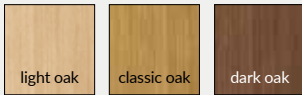

Model options with possibility to choose graphic patterns W1-W4 :

- M1 - full door leaf, without glazing
- M2 - MDF bulaj in black matt decor
- M3 - steel BULAJ in steel or black colour (only MATT or transparent glass pane available)
- M4 - MDF frame in black matt decor

STANDARD OPTIONS

- » door leaf surface coated with the primer material, overprinted with the pattern and varnished
- » matt lacquer
- » door leaf frame made of MDF
- » stabilising insert honeycomb
- » glass pane MAT DRE 4 mm thick

NON-REBATED DOOR LEAF

- » edge without rebate in the colour of the door leaf
- » sockets for 2 hidden recessed Estetic 80 hinges in steel colour (non-rebated door frames are equipped with hinges)
- » magnetic simple key lock, bathroom lock, cylinder insert lock or economic magnetic lock in steel colour

DOOR FRAMES

- » for the door leaves from the WOOD collection, we recommend to use lacquered frames made in the DRE-PRINT technology in the colour of door leaf unit

OPTION WITHOUT EXTRA CHARGE

- » holes for ventilation sleeves
- » glass pane DECORMAT BROWN, DECORMAT GRAPHITE and transparent glass pane

OPTIONS AVAILABLE WITH EXTRA CHARGE

- » door leaf „100”
- » stabilising insert tubular chipboard
- » ventilation undercut
- » **NOTE** : third Estetic 80 hinge for non-rebated doors (extra charge is added to the price of the door frame)
- » aluminum ventilation grille

fig. 1

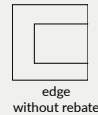

W1

W2

W3

W4



CLARO M1

Decor



white
lacquered

black
lacquered

HIGH GLOSS LACQUER AS STANDARD

- » door leaf surface is coated with primer material and varnished
- » gloss varnish
- » door leaf frame made of MDF
- » core made of perforated chipboard
- » 4mm MAT DRE glass pane

MATT LACQUER AS STANDARD

- » door leaf surface is coated with primer material and varnished
- » matt lacquer
- » door leaf frame made of MDF
- » core made of „honeycomb”
- » 4mm MAT DRE glass pane

NON-REBATED DOOR LEAF

- » edge without rebate in white or black colour fig.1
- » sockets for 2 hidden recessed Estetic 80 hinges in black or white colour (non-rebated door frames are equipped with hinges)
- » magnetic simple key lock, bathroom lock, cylinder insert lock or economic magnetic lock in black or white colour

DOOR FRAMES

- » for DRE-CLARO collection , we recommend to use white, black lacquered door frames made in DRE-PRINT technology, or door frames in black matt 2

OPTION WITHOUT EXTRA CHARGE

- » holes for ventilation sleeves
- » glass pane DECORMAT BROWN, DECORMAT GRAPHITE and transparent glass pane

OPTIONS AVAILABLE WITH EXTRA CHARGE

- » door leaf „100”
- » ventilation undercut
- » core made of tubular chipboard in matt lacquered door leaves
- » **NOTE** : third Estetic 80 hinge for non-rebated doors (extra charge is added to the price of the door frame)
- » aluminum ventilation grille

fig. 1

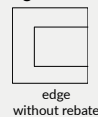

white edgeband,
white lock



black edgeband,
black lock



M 1 - CLARO

M 2 - CLARO

M 3 - CLARO

M 4 - CLARO

Possible model options:

- M1 - full door leaf, without glazing
- M2 - MDF bulaj in black matt decor
- M3 - steel bulaj (matt or transparent glass pane)
- M4 - MDF frame in black matt decor

steel BULAJ M3 - in steel or black colour. Only MATT or transparent glass pane available.



GRAFI M4-G2

STANDARD HIGH GLOSS LACQUERED DOOR LEAF

- » door leaf surface coated with the primer material, overprinted with the pattern and varnished (colour of the door leaf primed surface - white)
- » high gloss lacquer
- » door leaf frame made of MDF
- » core made of tubular chipboard
- » MAT DRE glass pane 4 mm thick (model M2, M4)

STANDARD MATT LACQUERED DOOR LEAF

- » door leaf surface coated with the primer material, overprinted with the pattern and varnished (colour of the door leaf primed surface - white)
- » matt lacquer
- » door leaf frame made of MDF
- » core made of „honeycomb”
- » MAT DRE glass pane 4 mm thick (model M2, M4)

NON-REBATED DOOR LEAF

- » edge without rebate in white or black colour fig.1
- » sockets for 2 hidden recessed Estetic 80 hinges in black or white colour (non-rebated door frames are equipped with hinges)
- » magnetic simple key lock, bathroom lock, cylinder insert lock or economic magnetic lock in black or white colour

DOOR FRAMES

- » for GRAFI collection , we recommend to use white, black lacquered door frames made in DRE-PRINT technology, or door frames in black matt 2

OPTION WITHOUT EXTRA CHARGE

- » holes for ventilation sleeves
- » DECORMAT BROWN, DECORMAT GRAPHITE glass pane and transparent glass

OPTIONS AVAILABLE WITH EXTRA CHARGE

- » door leaf „100”
- » ventilation undercut
- » core made of tubular chipboard in matt lacquered door leaves
- » **NOTE** : third Estetic 80 hinge for non-rebated doors (extra charge is added to the price of the door frame)
- » aluminum ventilation grille

fig. 1



edge without rebate



white edgeband, white lock



black edgeband, black lock

Model options with possibility to choose graphic patterns G1-G25 :

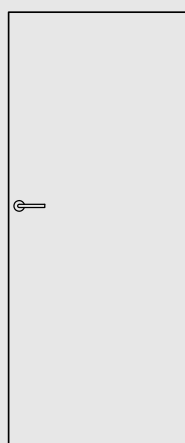

M1

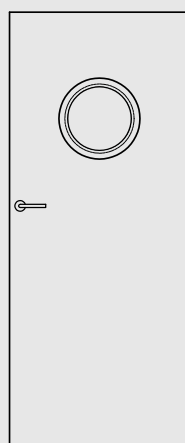

M2

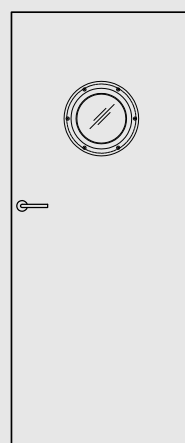

M3

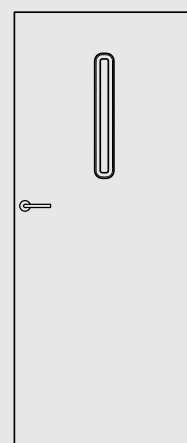

M4

- M1 - full door leaf, without glazing
- M2 - MDF bulaj in black matt decor
- M3 - steel BULAJ in steel or black colour (only MATT or transparent glass pane available)
- M4 - MDF frame in black matt decor

Graphic patterns available on pages 54-55, 162-165



G1



G2



G3



G4



G5



G6

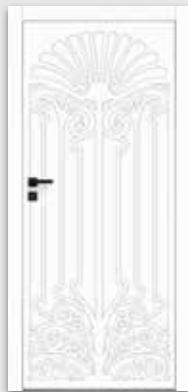

G7



G8



G9

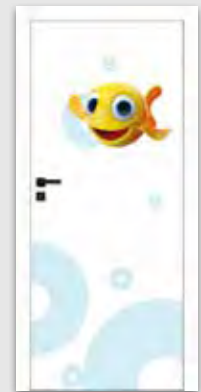

G10



G11



G12

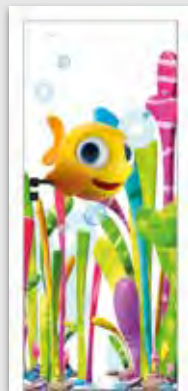

G13

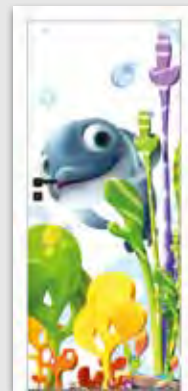

G14

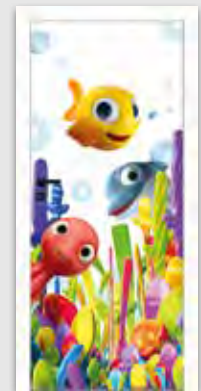

G15



G16



G17*



G18*



G19



G20*



GRAFI M1 G16



* pattern versions available for the right and left door leaf
 Door leaf width: single leaf door „60”÷”100” .
 Technical information: frames: p. 136, accessories: p. 153-159 and 169, door leaves: p. 170-178.



LUX 10 birch

Decor

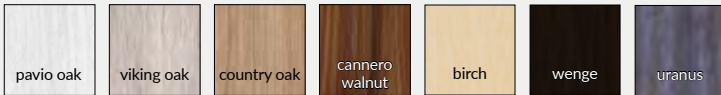

STANDARD OPTIONS

- » door leaf surface is coated with primer material in the colour of decor and varnished
- » high gloss lacquer
- » door leaf frame made of MDF
- » core made of perforated chipboard
- » MAT DRE glass pane 4 mm thick (model LUX 20, LUX 40)

NON-REBATED DOOR LEAF

- » edge without rebate in black colour fig.1
- » sockets for 2 hidden recessed Estetic 80 hinges in black colour (non-rebated door frames are equipped with hinges)
- » magnetic simple key lock, bathroom lock, cylinder insert lock or economic magnetic lock in black colour

DOOR FRAMES

for door leaves from LUX collection we recommend to use door frames lacquered in the same colour as the door leaf unit or in black matt decor 2

OPTION WITHOUT EXTRA CHARGE

- » holes for ventilation sleeves
- » DECORMAT BROWN, DECORMAT GRAPHITE glass pane and transparent glass

OPTIONS AVAILABLE WITH EXTRA CHARGE

- » door leaf „100”
- » ventilation undercut
- » **NOTE:** third Estetic 80 hinge for non-rebated doors (extra charge is added to the price of the door frame)
- » aluminum ventilation grille

fig. 1

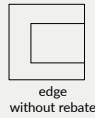

edge
without rebate



black edgeband,
black lock



LUX 10



LUX 20



LUX 30



LUX 40

steel BULAJ LUX 30- in the steel or black colour. Available only MATT or transparent glass pane.



Nova 10 - natural halifax oak

EGGER 3 mm
laminates
group 1



CLEAF 4 mm
laminates
group 2



STANDARD OPTIONS

- » door leaf surface is coated with laminated, synchronous 3 mm or 4 mm thick board
- » door leaf frame made of softwood
- » core made of „honeycomb“
- » glass pane MAT DRE 4 mm thick
- » edgeband in black colour

OPTIONS WITHOUT EXTRA CHARGE

- » ventilation sleeves
- » three hinges - applies to rebated door leaf
- » DECORMAT BROWN, DECORMAT GRAPHITE glass pane and transparent glass

REBATED DOOR LEAF

- » straight edge fig. 1
- » 2 silver screw-in pivot hinges
- » single-point, silver mortise lock for simple key, for bathroom, for cylinder insert or economic lock

NON-REBATED DOOR LEAF (extra charge)

- » edge without rebate fig. 2
- » sockets for 2 hidden recessed Estetic 80 hinges (hinges constitute a part of the door frame)
- » magnetic simple key lock, bathroom lock, cylinder insert lock or economic magnetic lock in black colour

SLIDING DOOR LEAF

- » edge without rebate fig. 2
- » socket for hook lock and/or for handles

DOOR FRAMES

- » for door leaves from NOVA collection it is recommended to use door frames in black matt decor in DRE-CELL foil black matt 2

OPTIONS AVAILABLE WITH EXTRA CHARGE

- » core made of tubular chipboard
- » non-rebated door leaf
- » door leaf „100“
- » ventilation undercut
- » plastic ventilation grille
- » aluminum ventilation grille
- » there is possibility to purchase black or stainless steel BULAJ separately
- » **NOTE:** third Estetic 80 hinge for non-rebated doors (extra charge is added to the price of the door frame)

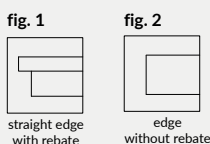

steel BULAJ NOVA 30 - in the steel or black colour. Available only MATT or transparent glass pane.



RIVIA 10 - white matt / vintage oak

Decor DRE-Cell	white matt	white pine	siberian elm	silver	sand oak	bleached oak textured	vintage oak	golden oak textured	walnut	caramel walnut	dark walnut textured
	gray oak textured	tabac elm	anthracite elm	dark wenge	gray textured	black textured	toffee oak	marrone chestnut textured	evoke oak	light gray matt	
Decor 3D	grand oak	elm	american walnut	ebony*	Polish oak 3D	<i>*while stock last</i>					

STANDARD OPTIONS

- » door leaf frame made of softwood
- » core made of tubular chipboard
- » glass pane white bark 4 mm thick

OPTIONS WITHOUT EXTRA CHARGE

- » glass pane „chinchila” or „window blind”
- » ventilation sleeves
- » three hinges - applies to rebated door leaf

REBATED DOOR LEAF

- » straight edge, flat uniform glass pane frame **fig. 1**
- » 2 silver screw-in pivot hinges
- » single-point mortise simple key lock, for bathroom lock, for cylinder lock or economic lock
- » NON-REBATED DOOR LEAF (extra charge)
- » edge without rebate, flat uniform glass pane frame, **fig. 2**
- » sockets for 2 hidden recessed Estetic 80 hinges (hinges constitute a part of the door frame)
- » magnetic simple key lock, bathroom lock, cylinder lock, economic lock

SLIDING DOOR LEAF

- » edge without rebate, flat uniform glass pane frame **fig. 2**
- » socket for hook lock and/or for handles

NOTE: Door leaf is coated with decor white matt. There is possibility to choose middle stripe in the selected decor. Edgeband is in the colour of selected decor. RIVIA 50 - BULAJ is coated with silver laminate.

By default , the configurator selects the colour of the door frame in the same colour as the middle stripe of the door leaf unit.

*** RIVIA 70 and 120 - Selected decor with vertical wood grain, except for gray oak texture. Other models with horizontal wood grain.

OPTIONS AVAILABLE WITH EXTRA CHARGE

- » glass pane MAT DRE, DECORMAT BROWN, DECORMAT GRAPHITE, (applies to door leaf)
RIVIA 20, 30
RIVIA 40, 50
- » white frost VSG 22,1 safe, complex glass pane
RIVIA 20, 30
RIVIA 40, 50
- » non-rebated door leaf
- » door leaf „90” and „100”
- » ventilation undercut
- » plastic ventilation grille
- » aluminum ventilation grille
- » **NOTE:** third Estetic 80 hinge for non-rebated doors (extra charge is added to the price of the door frame)

fig. 1

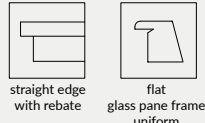
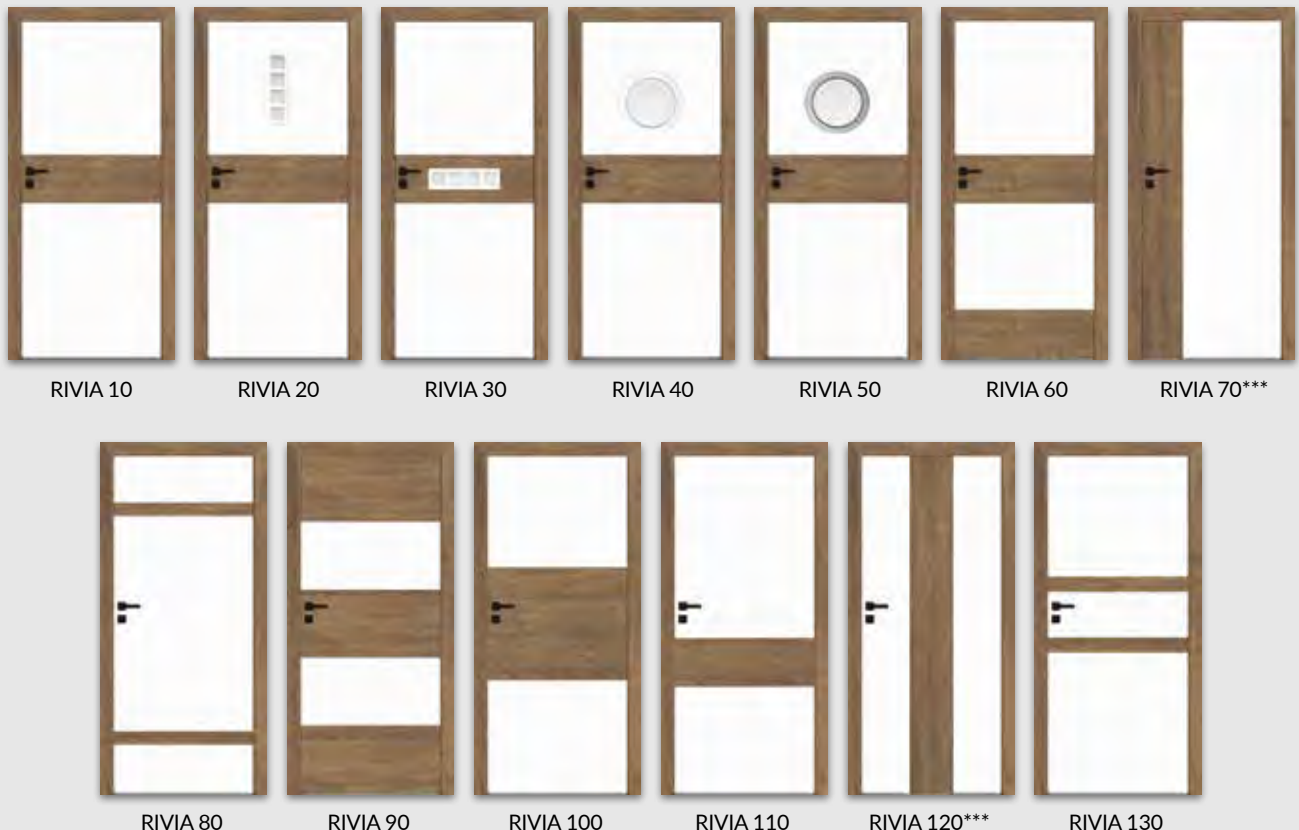
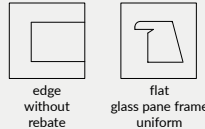

fig. 2





ALU 20 GALLERY - black textured

Decor DRE-Cell	white matt	white pine	siberian elm	silver	sand oak	bleached oak textured	vintage oak	caramel walnut	golden oak textured	dark walnut textured	gray oak textured***
	tabac elm**	anthracite elm	dark wenge	gray textured	black textured	toffee oak***	marrone chestnut textured	evoke oak	light gray matt	white (textured)	walnut
Decor 3D	grand oak	elm	american walnut	ebony**	Polish oak 3D						
Laminate CPL*	white	milky white	ashen	dark gray	concrete 2	gray oak	welsh oak				
	acacia	celini walnut	walnut	honey oak	chestnut	roasted walnut					

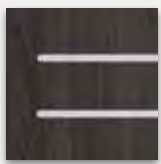

8mm inserts located in one plane with the door leaf surface on both sides

* laminate available in models 10, 20, 30, 50, 60

**while stock last

*** decor available only in horizontal wood grain

STANDARD OPTIONS

- » door leaf frame made of softwood
- » core made of tubular chipboard
- » edge with radius R 2,5 mm used in 0,15-0,20 mm CPL laminates
- » decorative inserts 8 mm
- » glass pane white bark 4 mm thick

OPTIONS WITHOUT EXTRA CHARGE

- » glass pane „chinchila” or „window blind”
- » ventilation sleeves
- » three hinges - applies to rebated door leaf

REBATED DOOR LEAF

- » straight edge, flat glass pane frame **fig. 1**
- » 2 silver screw-in pivot hinges
- » single-point mortise simple key lock, for bathroom lock, for cylinder lock or economic lock
- » straight edge or edge with radius R 2,5 mm made in directforming (in CPL laminate) **fig 3**

NON-REBATED DOOR LEAF (extra charge)

- » edge without rebate, flat glass pane frame **fig. 2**
- » sockets for 2 hidden recessed Estetic 80 hinges (hinges constitute a part of the door frame)
- » magnetic simple key lock, bathroom lock, cylinder lock, economic lock

SLIDING DOOR LEAF

- » edge without rebate, flat glass pane frame **fig. 2**
- » socket for hook lock and/or for handles

Note: passive door leaf GALERIA ALU 20, 21, 22, 23, 24, 25, 60 without horizontal inserts in a uniform grain.

OPTIONS AVAILABLE WITH EXTRA CHARGE

- » glass pane MAT DRE, DECORMAT BROWN, DECORMAT GRAPHITE, (applies to door leaf)
GALERIA ALU 11, 13, 23

GALERIA ALU 21

GALERIA ALU 24, 25

GALERIA ALU 12, 22

- » white frost VSG 22,1 safe, complex glass pane

GALERIA ALU 11

GALERIA ALU 13, 23

GALERIA ALU 21

GALERIA ALU 24

GALERIA ALU 25

GALERIA ALU 12

GALERIA ALU 22

- » non-rebated door leaf

- » door leaf "90" and "100"

- » ventilation undercut

- » plastic ventilation grille

- » aluminum ventilation grille

- » cover strip for double leaf non-rebated door

- » double leaf door

leaf price x2

- » **NOTE:** third Estetic 80 hinge for non-rebated doors (extra charge is added to the price of the door frame)

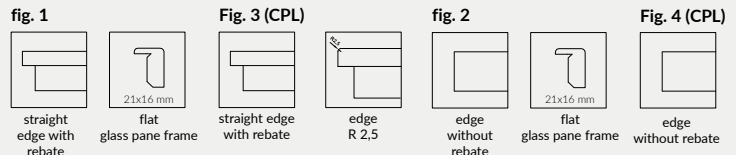



ARTE B 60 - caramel walnut

Decor DRE-Cell	white matt	white pine	siberian elm	silver	sand oak	bleached oak textured	vintage oak	caramel walnut	golden oak textured	dark walnut textured	gray oak textured***	evoke oak
	tabac elm	anthracite elm	dark wenge	gray textured	black textured	toffee oak ***	marrone chestnut textured	light gray matt	white (textured)	walnut		
Decor 3D	grand oak	elm	american walnut	ebony*	Polish oak 3D							

*** decor available only in horizontal wood grain

*while stock last

STANDARD OPTIONS

- » door leaf frame made of softwood
- » core made of „honeycomb“
- » glass pane white bark 4 mm thick

OPTIONS WITHOUT EXTRA CHARGE

- » glass pane „chinchila“ or „window blind“
- » ventilation sleeves
- » three hinges - applies to rebated door leaf

REBATED DOOR LEAF

- » straight edge, flat glass pane frame **fig. 1**
- » 2 silver screw-in pivot hinges
- » single-point mortise simple key lock, for bathroom lock, for cylinder lock or economic lock

NON-REBATED DOOR LEAF (extra charge)

- » edge without rebate, flat glass pane frame, **fig. 2**
- » sockets for 2 hidden recessed Estetic 80 hinges (hinges constitute a part of the door frame)
- » magnetic simple key lock, bathroom lock, cylinder lock, economic lock

SLIDING DOOR LEAF

- » edge without rebate, flat glass pane frame **fig. 2**
- » socket for hook lock and/or for handles

OPTIONS AVAILABLE WITH EXTRA CHARGE

- » glass pane MAT DRE, DECORMAT BROWN, DECORMAT GRAPHITE (applies to the door leaf)
- ARTE B 10, 20, 30
- ARTE B 40, 50
- ARTE B 60
- » white frost VSG 22,1 safe, complex glass pane
- ARTE B 10, 20, 30
- ARTE B 40, 50
- ARTE B 60
- » core made of tubular chipboard
- » non-rebated door leaf
- » door leaf „90“ and „100“
- » ventilation undercut
- » plastic ventilation grille
- » aluminum ventilation grille
- » cover strip for double leaf non-rebated door
- » double leaf door leaf price x2
- » **NOTE:** third Estetic 80 hinge for non-rebated doors (extra charge is added to the price of the door frame)

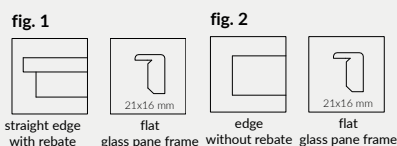



CARLA 10 bleached oak textured

Decor DRE-Cell	white matt	white pine	siberian elm	silver	sand oak	bleached oak textured	vintage oak	caramel walnut	golden oak textured	dark walnut textured	gray oak textured***	evoked oak
	tabac elm	anthracite elm	dark wenge	gray textured	black textured	toffee oak***	marrone chestnut textured	light gray matt	white (textured)	walnut		
Decor 3D	grand oak	elm	american walnut	ebony*	Polish oak 3D							

*** decor available only in horizontal wood grain

*while stock last

STANDARD OPTIONS

- » door leaf frame made of softwood
- » core made of „honeycomb“
- » glass pane white bark 4 mm thick

OPTIONS WITHOUT EXTRA CHARGE

- » glass pane „chinchila“ or „window blind“
- » ventilation sleeves
- » three hinges - applies to rebated door leaf

REBATED DOOR LEAF

- » straight edge, flat glass pane frame, 19 mm MDF profiled panels **fig. 1**
- » 2 silver screw-in pivot hinges
- » single-point mortise simple key lock, for bathroom lock, for cylinder lock or economic lock

NON-REBATED DOOR LEAF (extra charge)

- » edge without rebate, flat glass pane frame, 19 mm MDF profiled panels **fig. 2**
- » sockets for 2 hidden recessed Estetic 80 hinges (hinges constitute a part of the door frame)
- » magnetic simple key lock, bathroom lock, cylinder lock, economic lock

SLIDING DOOR LEAF

- » edge without rebate, flat glass pane frame, 19 mm MDF profiled panels **fig. 2**
- » socket for hook lock and/or for handles

OPTIONS AVAILABLE WITH EXTRA CHARGE

- » glass pane MAT DRE, DECORMAT BROWN, DECORMAT GRAPHITE (applies to door leaf)
CARLA 20
CARLA 30
CARLA 40
- » white frost VSG 22,1 safe, complex glass pane
CARLA 20
CARLA 30
CARLA 40
- » core made of tubular chipboard
- » non-rebated door leaf
- » door leaf "90" and "100"
- » ventilation undercut
- » plastic ventilation grille
- » aluminum ventilation grille
- » cover strip for double leaf non-rebated door
- » double leaf door leaf price x2
- » **NOTE:** third Estetic 80 hinge for non-rebated doors (extra charge is added to the price of the door frame)

fig. 1

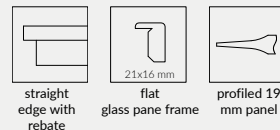
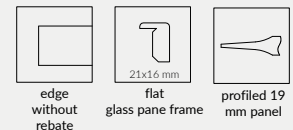

fig. 2



CARLA 10

CARLA 20

CARLA 30

CARLA 40



FINEA 40 vintage oak

Decor DRE-Cell	white matt	white pine	siberian elm	silver	sand oak	bleached oak textured	vintage oak	caramel walnut	golden oak textured	dark walnut textured	gray oak textured	evoked oak
	tabac elm	anthracite elm	dark wenge	gray textured	black textured	toffee oak	marrone chestnut textured	light gray matt	white (textured)	walnut		
Decor 3D	grand oak	elm	american walnut	ebony*	Polish oak 3D							

*while stock last

STANDARD OPTIONS

- » door leaf frame made of softwood
- » core made of tubular chipboard
- » glass pane white bark 4 mm thick

OPTIONS WITHOUT EXTRA CHARGE

- » glass pane „chinchila” or „window blind”
- » ventilation sleeves
- » three hinges - applies to rebated door leaf

REBATED DOOR LEAF

- » straight edge, flat glass pane frame **fig. 1**
- » 2 silver screw-in pivot hinges
- » single-point mortise simple key lock, for bathroom lock, for cylinder lock or economic lock

NON-REBATED DOOR LEAF (extra charge)

- » edge without rebate, flat glass pane frame **fig. 2**
- » sockets for 2 hidden recessed Estetic 80 hinges (hinges constitute a part of the door frame)
- » magnetic simple key lock, bathroom lock, cylinder lock, economic lock

SLIDING DOOR LEAF

- » edge without rebate, flat glass pane frame **fig. 2**
- » socket for hook lock and/or for handles

OPTIONS AVAILABLE WITH EXTRA CHARGE

- » glass pane MAT DRE, DECORMAT BROWN, DECORMAT GRAPHITE (applies to door leaf)
FINEA 20, FINEA B 20
FINEA 30, 50, 60, FINEA B 30, 50, 60
- » white frost VSG 22,1 safe, complex glass pane
FINEA 20, FINEA B 20
FINEA 30, FINEA B 30
FINEA 50, 60, FINEA B 50, 60
- » non-rebated door leaf
- » door leaf „90” and „100”
- » ventilation undercut
- » plastic ventilation grille
- » aluminum ventilation grille
- » **NOTE:** third Estetic 80 hinge for non-rebated doors (extra charge is added to the price of the door frame)

fig. 1



straight edge with rebate



flat glass pane frame
21x16 mm

fig. 2



edge without rebate



flat glass pane frame
21x16 mm



FINEA 10
FINEA B 10*



FINEA 20
FINEA B 20*



FINEA 30
FINEA B 30*



FINEA 40
FINEA B 40*



FINEA 50
FINEA B 50*



FINEA 60
FINEA B 60*

* FINEA B panels available only with horizontal wood grain

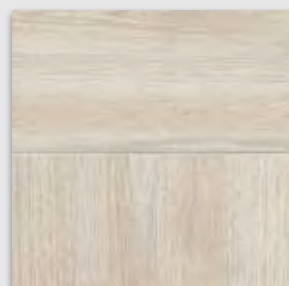

panels wood grain in FINEA

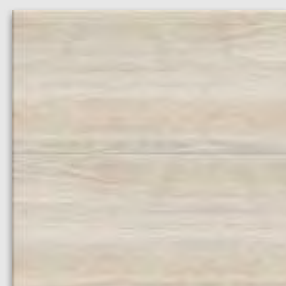

panels horizontal wood grain
FINEA B



DECO 20 - toffee oak

Decor DRE-Cell	white matt	white pine	siberian elm	silver	sand oak	bleached oak textured	vintage oak	caramel walnut	golden oak textured	dark walnut textured	gray oak textured***	evoke oak
	tabac elm	anthracite elm	dark wenge	gray textured	black textured	toffee oak ***	marrone chestnut textured	light gray matt	white (textured)	walnut		
Decor 3D	grand oak	elm	american walnut	ebony*	Polish oak 3D							
CPL Lami- nate	white	milky white	ashen	dark gray	concrete 2	gray oak	welsh oak					
	acacia	celini walnut	walnut	honey oak	chestnut	roasted walnut						

*** decor available only in horizontal wood grain

*while stock last

STANDARD OPTIONS

- » door leaf frame made of softwood
- » edge with radius R 2,5 mm used in 0,15-0,20 mm CPL laminates
- » core made of „honeycomb“
- » glass pane white bark 4 mm thick
- » flat 4mm HDF panel in DECO 40

OPTIONS WITHOUT EXTRA CHARGE

- » glass pane „chinchila“ or „window blind“
- » ventilation sleeves
- » three hinges - applies to rebated door leaf

REBATED DOOR LEAF

- » straight edge, flat glass pane frame **Fig. 1** in the door leaf decor or black Slim
- » 2 silver screw-in pivot hinges
- » single-point mortise simple key lock, for bathroom lock, for cylinder lock or economic lock
- » rounded glass pane frame, straight edge or edge with radius R 2,5 mm made in directforming (in CPL laminate)

NON-REBATED DOOR LEAF (extra charge)

- » non-rebated edge, flat glass pane frame **Fig. 2** in the leaf decor or black Slim
- » sockets for 2 hidden recessed Estetic 80 hinges (hinges constitute a part of the door frame)
- » magnetic simple key lock, bathroom lock, cylinder lock, economic lock
- » edge without rebate, rounded glass pane frame (in CPL laminate) **fig. 5**

SLIDING DOOR LEAF

- » non-rebated edge and a choice of: flat glass pane frame in the leaf decor or black Slim, **fig. 2** or a rounded glass pane frame **fig. 3**
- » socket for hook lock and/or for handles
- » edge without rebate, rounded glass pane frame (in CPL laminate) **fig. 5**

OPTIONS AVAILABLE WITH EXTRA CHARGE

- » glass pane MAT DRE, DECORMAT BROWN , DECORMAT GRAPHITE (applies to door leaf) DECO 10, 20, 30
- » white frost VSG 22,1 safe, complex glass pane DECO 10, 20, 30
- » core made of tubular chipboard
- » non-rebated door leaf
- » door leaf "90" and "100"
- » ventilation undercut
- » plastic ventilation grille
- » aluminum ventilation grille
- » cover strip for double leaf non-rebated door
- » double leaf door leaf price x2
- » **NOTE:** third Estetic 80 hinge for non-rebated doors (extra charge is added to the price of the door frame)

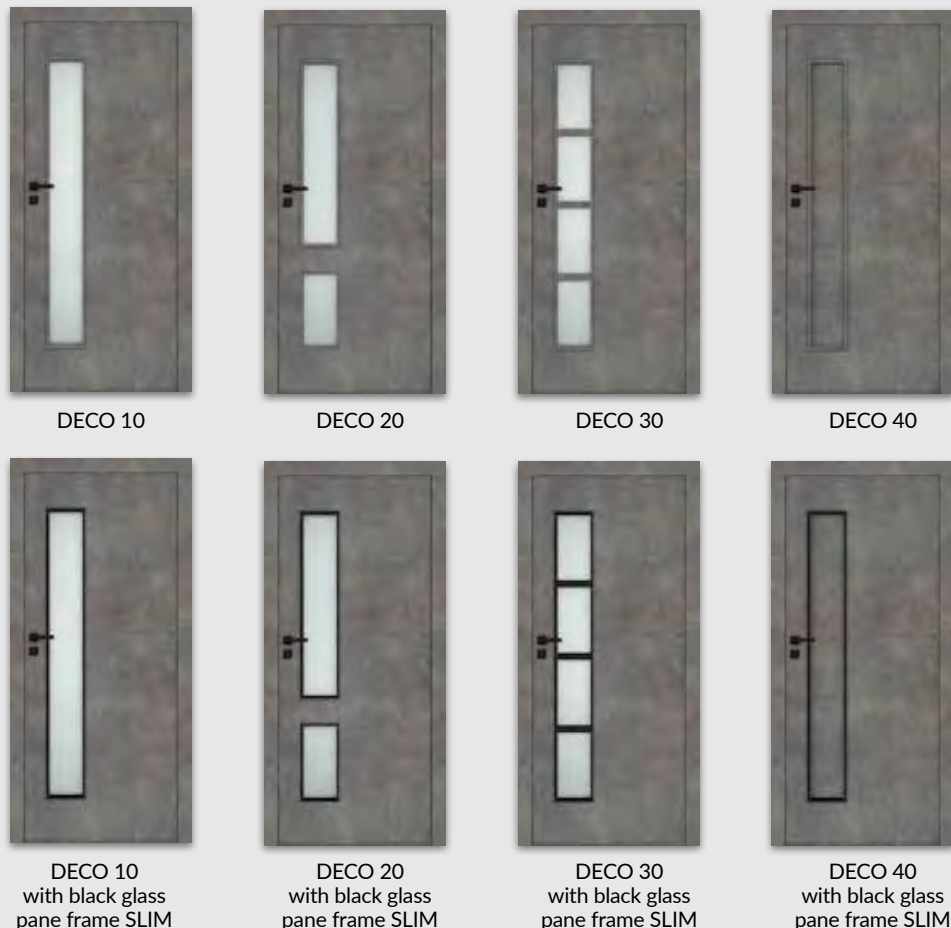
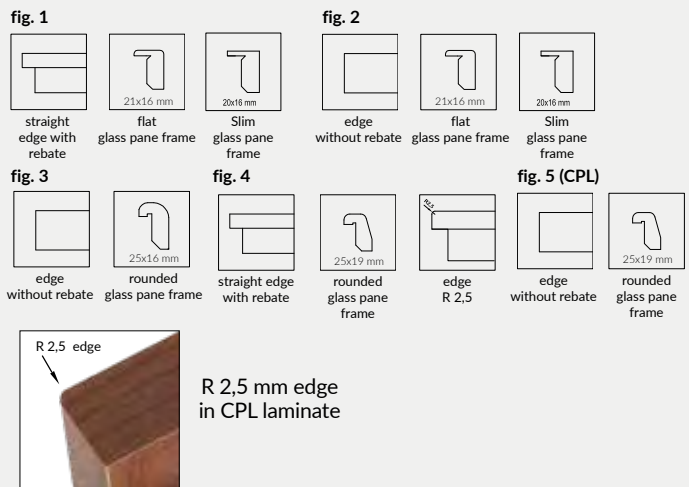



MODERN 30 - black textured

Decor DRE-Cell	white matt	white pine	siberian elm	silver	sand oak	bleached oak textured	vintage oak	caramel walnut	golden oak textured	dark walnut textured	gray oak textured***	evoke oak
	tabac elm	anthracite elm	dark wenge	gray textured	black textured	toffee oak***	marrone chestnut textured	light gray matt	white (textured)	walnut		
Decor 3D	grand oak	elm	american walnut	ebony*	Polish oak 3D							

*** decor available only in horizontal wood grain

*while stock last

STANDARD OPTIONS

- » door leaf frame made of softwood
- » core made of „honeycomb”
- » glass pane white bark 4 mm thick

OPTIONS WITHOUT EXTRA CHARGE

- » glass pane „chinchila” or „window blind”
- » ventilation sleeves
- » three hinges - applies to rebated door leaf

REBATED DOOR LEAF

- » straight edge, flat glass pane frame in the door leaf decor or black Slim, flat HDF panels, 4 mm thickness **fig. 1**
- » 2 silver screw-in pivot hinges
- » single-point mortise simple key lock, for bathroom lock, for cylinder lock or economic lock

NON-REBATED DOOR LEAF (extra charge)

- » non-rebated edge, flat glass pane frame in the door leaf decor or black Slim, flat HDF panels, 4 mm thickness **fig. 2**
- » sockets for 2 hidden recessed Estetic 80 hinges (hinges constitute a part of the door frame)
- » magnetic simple key lock, bathroom lock, cylinder lock, economic lock

SLIDING DOOR LEAF

- » non-rebated edge and a choice of: flat glass pane frame in the door leaf decor or black Slim, flat HDF panels, 4 mm thickness **fig. 2** or a rounded glass pane frame, profiled MDF panels, 19 mm thickness **fig. 3**
- » socket for hook lock and/or for handles

OPTIONS AVAILABLE WITH EXTRA CHARGE

- » glass pane MAT DRE, DECORMAT BROWN, DECORMAT GRAPHITE, (applies to door leaf)
MODERN 20
MODERN 30
MODERN 40
MODERN 50
- » white frost VSG 22,1 safe, complex glass pane
MODERN 20
MODERN 30
MODERN 40
MODERN 50
- » core made of tubular chipboard
- » non-rebated door leaf
- » door leaf "90" and "100"
- » ventilation undercut
- » plastic ventilation grille
- » aluminum ventilation grille
- » cover strip for double leaf non-rebated door
- » double leaf door leaf price x2
- » **NOTE:** third Estetic 80 hinge for non-rebated doors (extra charge is added to the price of the door frame)

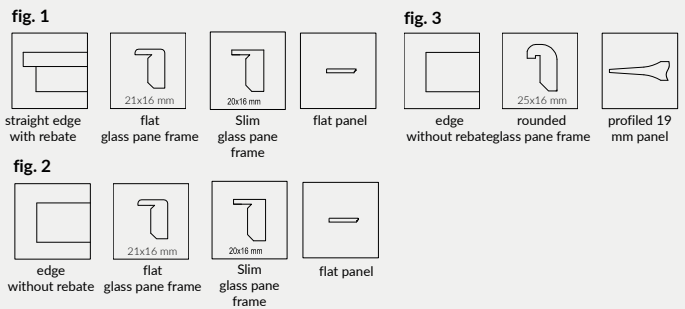

MODERN 10

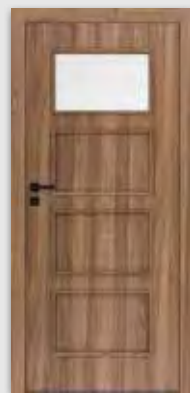

MODERN 20

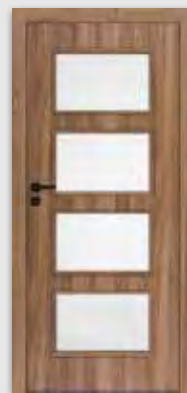

MODERN 30

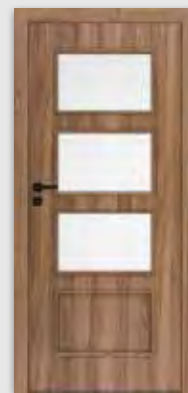

MODERN 40

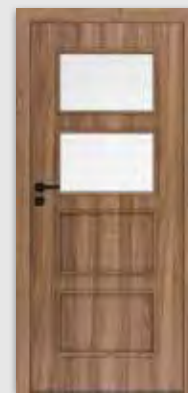

MODERN 50



MODERN 10
with black glass
pane frame
SLIM



MODERN 20
with black glass
pane frame
SLIM



MODERN 30
with black glass
pane frame SLIM



MODERN 40
with black glass
pane frame SLIM



MODERN 50
with black glass
pane frame SLIM



KANON 10 - American walnut, black glass pane frames

Decor DRE-Cell	white matt	white pine	siberian elm	silver	sand oak	bleached oak textured	vintage oak	caramel walnut	golden oak textured	dark walnut textured	gray oak textured***	evoke oak
	tabac elm	anthracite elm	dark wenge	gray textured	black textured	toffee oak***	marrone chestnut textured	light gray matt	white (textured)	walnut		
Decor 3D	grand oak	elm	american walnut	ebony*	Polish oak 3D							

*** decor available only in horizontal wood grain

*while stock last

STANDARD OPTIONS

- » door leaf frame made of softwood
- » core made of „honeycomb“
- » glass pane white bark 4 mm thick

OPTIONS WITHOUT EXTRA CHARGE

- » glass pane „chinchila“ or „window blind“
- » ventilation sleeves
- » three hinges - applies to rebated door leaf

REBATED DOOR LEAF

- » straight edge, flat glass pane frame in the door leaf decor or black Slim, flat HDF panels, 4 mm thickness **fig. 1**
- » 2 silver screw-in pivot hinges
- » single-point mortise simple key lock, for bathroom lock, for cylinder lock or economic lock

NON-REBATED DOOR LEAF (extra charge)

- » non-rebated edge, flat glass pane frame in the door leaf decor or black Slim, flat HDF panels, 4 mm thickness **fig. 2**
- » sockets for 2 hidden recessed Estetic 80 hinges (hinges constitute a part of the door frame)
- » magnetic simple key lock, bathroom lock, cylinder lock, economic lock

SLIDING DOOR LEAF

- » non-rebated edge and a choice of: flat glass pane frame in the door leaf decor or black Slim, flat HDF panels, 4 mm thickness **fig. 2** or a rounded glass pane frame, profiled MDF panels, 19 mm thickness **fig. 3**
- » socket for hook lock and/or for handles

OPTIONS AVAILABLE WITH EXTRA CHARGE

- » glass pane MAT DRE, DECORMAT BROWN, DECORMAT GRAPHITE, (applies to door leaf)
KANON 20
KANON 30
KANON 40
- » white frost VSG 22,1 safe, complex glass pane
KANON 20
KANON 30
KANON 40
- » core made of tubular chipboard
- » non-rebated door leaf
- » door leaf "90" and "100"
- » ventilation undercut
- » plastic ventilation grille
- » aluminum ventilation grille
- » cover strip for double leaf non-rebated door
- » double leaf door leaf price x2
- » **NOTE:** third Estetic 80 hinge for non-rebated doors (extra charge is added to the price of the door frame)

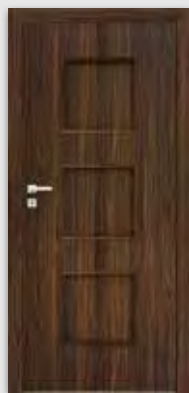
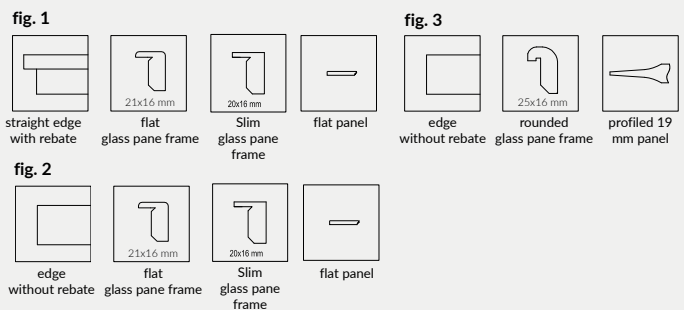

KANON 10

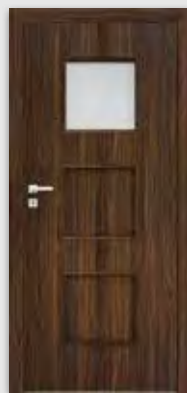

KANON 20



KANON 30



KANON 40

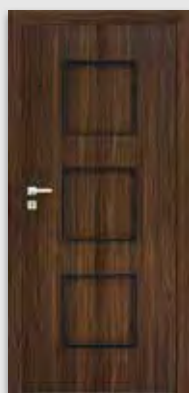

KANON 10
with black glass
pane frame
SLIM

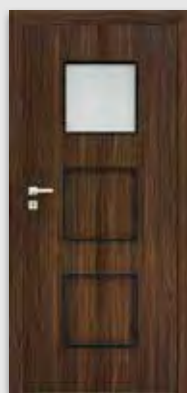

KANON 20
with black glass
pane frame
SLIM

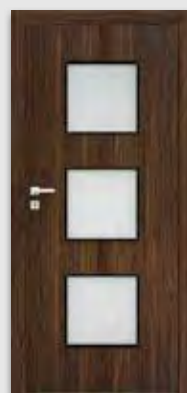

KANON 30
with black glass
pane frame SLIM

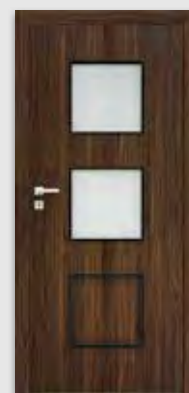

KANON 40
with black glass
pane frame SLIM



PLUS 30 - white matt

Decor DRE-Cell	white matt	white pine	siberian elm	silver	sand oak	bleached oak textured	vintage oak	caramel walnut	golden oak textured	dark walnut textured	gray oak textured***	evoke oak
	tabac elm	anthracite elm	dark wenge	gray textured	black textured	toffee oak ***	marrone chestnut textured	light gray matt	white (textured)	walnut		
Decor 3D	grand oak	elm	american walnut	ebony*	Polish oak 3D							

*** decor available only in horizontal wood grain

*while stock last

STANDARD OPTIONS

- » door leaf frame made of softwood
- » core made of „honeycomb“
- » glass pane white bark 4 mm thick

OPTIONS WITHOUT EXTRA CHARGE

- » glass pane „chinchila“ or „window blind“
- » ventilation sleeves
- » three hinges - applies to rebated door leaf

REBATED DOOR LEAF

- » edge without rebate, flat glass pane frame, flat 4 mm HDF panels fig. 1
- » 2 silver screw-in pivot hinges
- » single-point mortise simple key lock, for bathroom lock, for cylinder lock or economic lock

NON-REBATED DOOR LEAF (extra charge)

- » edge without rebate, flat glass pane frame, flat 4 mm HDF panels fig. 2
- » sockets for 2 hidden recessed Estetic 80 hinges (hinges constitute a part of the door frame)
- » magnetic simple key lock, bathroom lock, cylinder lock, economic lock

SLIDING DOOR LEAF

- » edge without rebate, flat 4 mm HDF panels and optional: flat glass pane frame, fig. 2 or rounded glass pane frame fig. 3
- » socket for hook lock and/or for handles

OPTIONS AVAILABLE WITH EXTRA CHARGE

- » glass pane MAT DRE, DECORMAT BROWN, DECORMAT GRAPHITE (applies to door leaf)
PLUS 20
PLUS 40, 50, 60, 70, 80
PLUS 30
- » white frost VSG 22,1 safe, complex glass pane
PLUS 20
PLUS 30
PLUS 40
PLUS 70, 80
- » core made of tubular chipboard
- » non-rebated door leaf
- » door leaf "90" and "100"
- » ventilation undercut
- » plastic ventilation grille
- » aluminum ventilation grille
- » cover strip for double leaf non-rebated door
- » double leaf door leaf price x2
- » **NOTE:** third Estetic 80 hinge for non-rebated doors (extra charge is added to the price of the door frame)

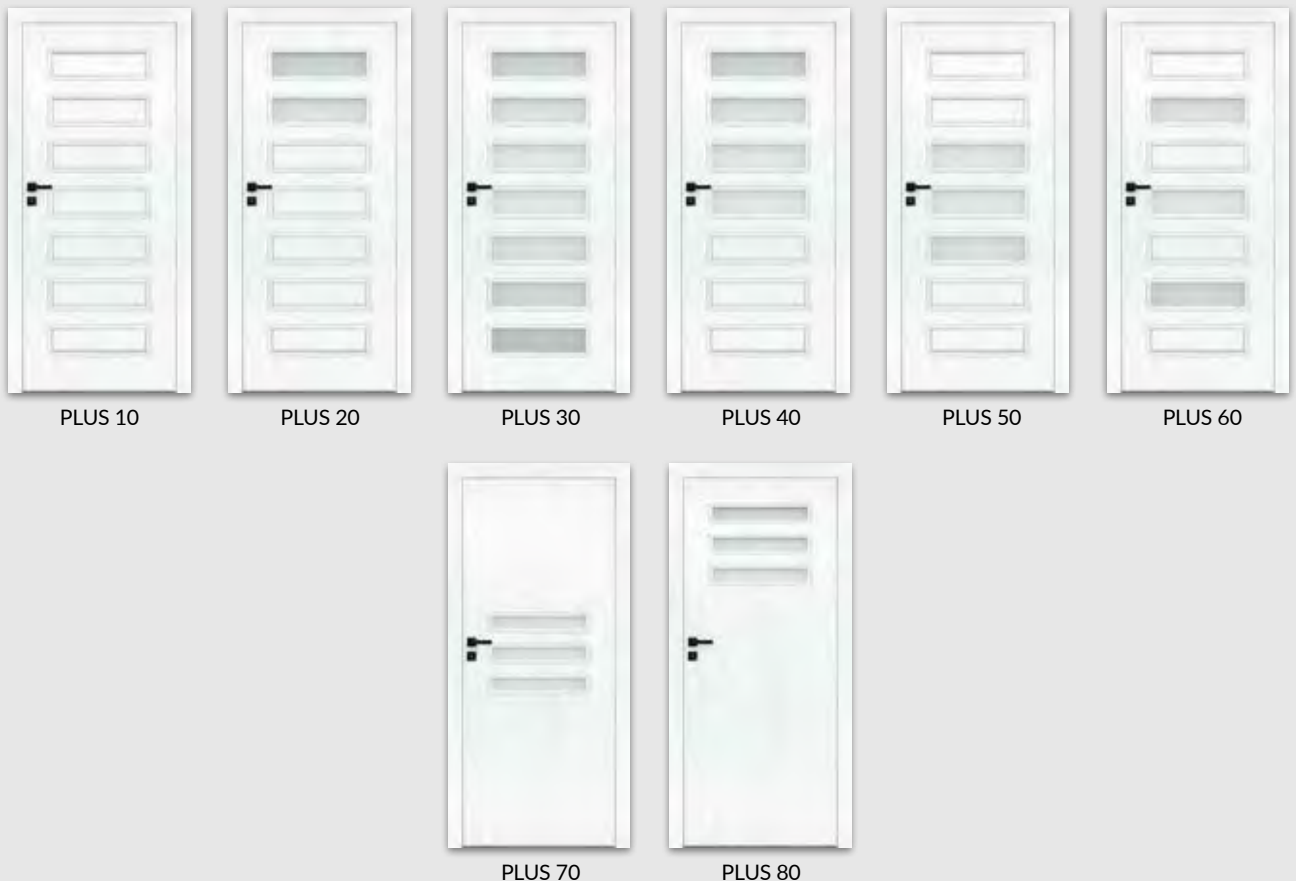
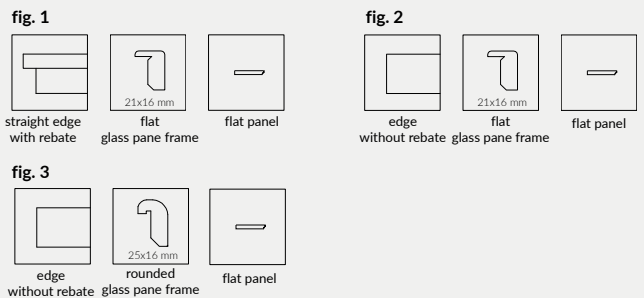



STANDARD 10 - evoke oak

Decor DRE-Cell	white matt	white pine	siberian elm	silver	sand oak	bleached oak textured	vintage oak	caramel walnut	golden oak textured	dark walnut textured	gray oak textured***	evoke oak
	tabac elm	anthracite elm	dark wenge	gray textured	black textured	toffee oak ***	marrone chestnut textured	light gray matt	white (textured)	walnut		
Decor 3D	grand oak	elm	american walnut	ebony*	Polish oak 3D							

*** decor available only in horizontal wood grain

*while stock last

STANDARD OPTIONS

- » door leaf frame made of softwood
- » core made of „honeycomb”
- » glass pane white bark 4 mm thick

OPTIONS WITHOUT EXTRA CHARGE

- » glass pane „chinchila” or „window blind”
- » ventilation sleeves
- » three hinges - applies to rebated door leaf

REBATED DOOR LEAF

- » straight edge, flat glass pane frame **fig. 1**
- » 2 silver screw-in pivot hinges
- » single-point mortise simple key lock, for bathroom lock, for cylinder lock or economic lock
- » **All orders in the investment standard require approval of the Investment Department. The investment standard, is defined by door frame passage, with opened door leaf at 90 degree, respectively for interior doors: "80" 800 mm, "90" 900 mm.**

NON-REBATED DOOR LEAF (extra charge)

- » edge without rebate, flat glass pane frame **fig. 2**
- » sockets for 2 hidden recessed Estetic 80 hinges (hinges constitute a part of the door frame)
- » magnetic simple key lock, bathroom lock, cylinder lock, economic lock

SLIDING DOOR LEAF

- » edge without rebate and optional: flat glass pane frame **fig.2** or rounded glass pane frame **fig. 3**
- » socket for hook lock and/or for handles

OPTIONS AVAILABLE WITH EXTRA CHARGE

- » glass pane MAT DRE, DECORMAT BROWN, DECORMAT GRAPHITE (applies to door leaf) STANDARD 20, 20s, 40, 40s, BULAJ MDF
- STANDARD 50, 50s
- STANDARD 30, 30s
- STANDARD 60
- » white frost VSG 22,1 safe, complex glass pane
- STANDARD 20, 20s, 40, 40s
- STANDARD 50, 50s, MDF PORTHOLE
- STANDARD 30, 30s
- STANDARD 60
- » core made of tubular chipboard
- » non-rebated door leaf
- » door leaf "90" and "100"
- » rebated door leaf "110" (only STANDARD 10)
- » additional upper single point mortise lock (available only in STANDARD 10 door leaf model with core made of tubular chipboard and fixed door frame)
- » ventilation undercut
- » plastic ventilation grille
- » aluminum ventilation grille
- » cover strip for double leaf non-rebated door
- » double leaf door door leaf price x 2
- » there is possibility to purchase steel BULAJ separately in black or steel colour
- » **NOTE:** third Estetic 80 hinge for non-rebated doors (extra charge is added to the price of the door frame)

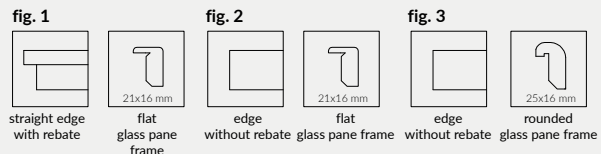



FANO 10 - elm

Decor DRE-Cell	white matt	white pine	siberian elm	silver	sand oak	bleached oak textured	vintage oak	caramel walnut	golden oak textured	dark walnut textured	gray oak textured***	tabac elm	anthracite elm	dark wenge
	gray textured	black textured	toffee oak ***	marrone chestnut textured	evoke oak	light gray matt	white (textured)	walnut						
Decor 3D	grand oak	elm	american walnut	ebony*	Polish oak 3D									

*** decor available only in horizontal wood grain

*while stock last

STANDARD OPTIONS

- » door leaf frame made of softwood
- » core made of „honeycomb”
- » glass pane white bark 4 mm thick

OPTIONS WITHOUT EXTRA CHARGE

- » glass pane „chinchila” or „window blind”
- » ventilation sleeves
- » three hinges - applies to rebated door leaf

REBATED DOOR LEAF

- » straight edge, flat glass pane frame **fig. 1**
- » 2 silver screw-in pivot hinges
- » single-point mortise simple key lock, for bathroom lock, for cylinder lock or economic lock

NON-REBATED DOOR LEAF (extra charge)

- » edge without rebate, flat glass pane frame, 19 mm MDF profiled panels **fig. 2**
- » sockets for 2 hidden recessed Estetic 80 hinges (hinges constitute a part of the door frame)
- » magnetic simple key lock, bathroom lock, cylinder lock, economic lock

SLIDING DOOR LEAF

- » edge without rebate, rounded glass pane frame or flat glass pane frame, profiled 19 mm MDF panel **fig. 3**
- » socket for hook lock and/or for handles

OPTIONS AVAILABLE WITH EXTRA CHARGE

- » glass pane MAT DRE, DECORMAT BROWN, DECORMAT GRAPHITE (applies to door leaf) FANO 20, 20s FANO 30, 30s
- » white frost VSG 22,1 safe, complex glass pane FANO 20, 20s FANO 30, 30s
- » core made of tubular chipboard
- » non-rebated door leaf
- » door leaf "90" and "100"
- » ventilation undercut
- » plastic ventilation grille
- » aluminum ventilation grille
- » cover strip for double leaf non-rebated door
- » double leaf door leaf price x2
- » **NOTE:** third Estetic 80 hinge for non-rebated doors (extra charge is added to the price of the door frame)

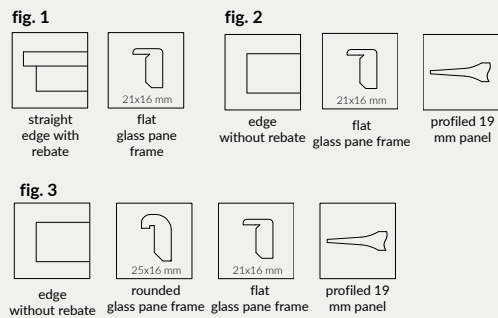



ARTE 40 - sand oak

Decor DRE-Cell	white matt	white pine	siberian elm	silver	sand oak	bleached oak textured	vintage oak	caramel walnut	golden oak textured	dark walnut textured	gray oak textured***	tabac elm	anthracite elm	dark wenge
	gray textured	black textured	toffee oak	marrone chestnut textured	evoke oak	light gray matt	white (textured)	walnut						
Decor 3D	grand oak	elm	american walnut	ebony*	Polish oak 3D									

*** decor available only in horizontal wood grain

*while stock last

STANDARD OPTIONS

- » door leaf frame made of softwood
- » core made of „honeycomb“
- » glass pane white bark 4 mm thick

OPTIONS WITHOUT EXTRA CHARGE

- » glass pane „chinchila“ or „window blind“
- » ventilation sleeves
- » three hinges - applies to rebated door leaf

REBATED DOOR LEAF

- » straight edge, flat glass pane frame **fig. 1**
- » 2 silver screw-in pivot hinges
- » single-point mortise simple key lock, for bathroom lock, for cylinder lock or economic lock

NON-REBATED DOOR LEAF (extra charge)

- » edge without rebate, flat glass pane frame **fig. 2**
- » sockets for 2 hidden recessed Estetic 80 hinges (hinges constitute a part of the door frame)
- » magnetic simple key lock, bathroom lock, cylinder lock, economic lock

SLIDING DOOR LEAF

- » edge without rebate, rounded glass pane frame or flat glass pane frame **fig. 3**
- » socket for hook lock and/or for handles

OPTIONS AVAILABLE WITH EXTRA CHARGE

- » glass pane MAT DRE, DECORMAT BROWN, DECORMAT GRAPHITE (applies to door leaf) ARTE 10-30, 90 ARTE 40, 50 ARTE 80
- » white frost VSG 22,1 safe, complex glass pane ARTE 10, 20, 30 ARTE 40, 50 ARTE 80 ARTE 90
- » core made of tubular chipboard
- » non-rebated door leaf
- » door leaf "90" and "100"
- » ventilation undercut
- » plastic ventilation grille
- » aluminum ventilation grille
- » cover strip for double leaf non-rebated door
- » double leaf door leaf price x2
- » **NOTE:** third Estetic 80 hinge for non-rebated doors (extra charge is added to the price of the door frame)

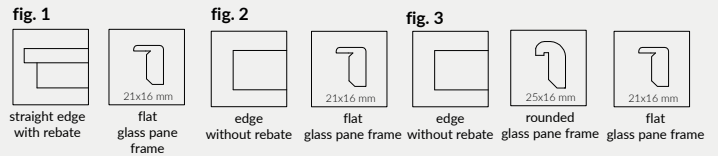



UNI 10 - ashen

Decor



white acrylic UV varnish - RAL 9003
 ecru - RAL 9001
 latte - Flugger 4362, NCS S1505-Y50R
 ashen - RAL 7035

**BEST
 PRICE**

STANDARD OPTIONS

- » door leaf painted with acrylic UV varnish
- » door leaf frame made of MDF
- » core made of „honeycomb”
- » glass pane white bark 4 mm thick

OPTIONS WITHOUT EXTRA CHARGE

- » glass pane „chinchila” or „window blind”
- » ventilation sleeves
- » third hinge to rebated door leaf

NOTE: To ensure highest quality of painted products, before painting process, both, door leaf and door frames are coated with special material which constitutes solid base.

REBATED DOOR LEAF

- » straight edge **fig. 1**
- » 2 silver screw-in pivot hinges
- » single-point mortise simple key lock, for bathroom lock, for cylinder lock or economic lock

NON-REBATED DOOR LEAF (extra charge)

- » edge without rebate **fig. 2**
- » sockets for 2 hidden recessed Estetic 80 hinges (hinges constitute a part of the door frame)
- » magnetic simple key lock, bathroom lock, cylinder insert lock or economic magnetic lock in steel, black or white colour

SLIDING DOOR LEAF

- » edge without rebate **fig. 2**
- » socket for hook lock and/or for handles

INVERTED REBATE DOOR LEAF (EXTRA CHARGE)

- » active single leaf door
- » straight edge **fig 3**
- » sockets for two recessed Estetic 1821 hinges (hinges constitute a part of the door frame)
- » magnetic simple key lock, bathroom lock, cylinder lock, economic lock

OPTIONS AVAILABLE WITH EXTRA CHARGE

- » glass pane MAT DRE, DECORMAT BROWN, DECORMAT GRAPHITE (applies to door leaf BULAJ MDF)
- » white frost VSG 22,1 safe, complex glass pane BULAJ MDF
- » core made of tubular chipboard
- » core made of full chipboard
- » door leaf "90" and "100"
- » ventilation undercut
- » non-rebated door leaf
- » door leaf with inverted rebate
- » cover strip for double leaf non-rebated door
- » plastic ventilation grille
- » aluminum ventilation grille
- » double leaf door leaf price x2
- » there is possibility to purchase steel BULAJ separately in black or steel colour
- » **NOTE:** third Estetic 80 hinge for non-rebated doors (extra charge is added to the price of the door frame)

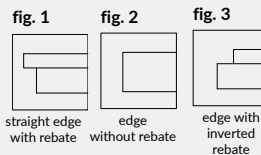

* Note: selected configurations of white rebated UNI 10 model are available in stock.



* only MATT or transparent glass pane available



FARGO 10 - ashen

Decor



white acrylic UV varnish - RAL 9003
ecru - RAL 9001
latte - Flugger 4362, NCS S1505-Y50R
ashen - RAL 7035

**BEST
PRICE**



STANDARD OPTIONS

- » door leaf painted with acrylic UV varnish
- » door leaf frame made of MDF
- » core made of „honeycomb”

OPTIONS WITHOUT EXTRA CHARGE

- » ventilation sleeves
- » three hinges - applies to rebated door leaf

NOTE: To ensure highest quality of painted products, before painting process, both, door leaf and door frames are coated with special material which constitutes solid base.

REBATED DOOR LEAF

- » straight edge **fig. 1**
- » 2 silver screw-in pivot hinges
- » single-point mortise simple key lock, for bathroom lock, for cylinder lock or economic lock

NON-REBATED DOOR LEAF (extra charge)

- » edge without rebate **fig. 2**
- » sockets for 2 hidden recessed Estetic 80 hinges (hinges constitute a part of the door frame)
- » magnetic simple key lock, bathroom lock, cylinder insert lock or economic magnetic lock in steel, black or white colour

SLIDING DOOR LEAF

- » edge without rebate **fig. 2**
- » socket for hook lock and/or for handles

INVERTED REBATE DOOR LEAF (EXTRA CHARGE)

- » active single leaf door
- » straight edge **fig 3**
- » sockets for two recessed Estetic 1821 hinges (hinges constitute a part of the door frame)
- » magnetic simple key lock, bathroom lock, cylinder lock, economic lock

OPTIONS AVAILABLE WITH EXTRA CHARGE

- » door leaf "90" and "100"
 - » tubular chipboard
 - » core made of full chipboard
 - » ventilation undercut
 - » non-rebated door leaf
 - » door leaf with inverted rebate
 - » cover strip for double leaf non-rebated door
 - » plastic ventilation grille
 - » aluminum ventilation grille
 - » double leaf door
 - » **NOTE:** third Estetic 80 hinge for non-rebated doors (extra charge is added to the price of the door frame)
- leaf price x2

fig. 1



straight edge
with rebate

fig. 2



edge
without rebate

fig. 3



edge with
inverted rebate



milling type in FARGO collection



FARGO 10



FARGO 20



FARGO 30



FARGO 40



FARGO 50



FARGO 60



BINITO 20 white acrylic UV lacquer

Decor



white acrylic UV varnish - RAL 9003
 ecru - RAL 9001
 latte - Flugger 4362, NCS S1505-Y50R
 ashen - RAL 7035

WEGA DOOR HANDLE WITH A BACKPLATE

(available only with rebated and non-rebated door leaf in BINITO collection)
 black matt finish handle and backplate



milling type in BINITO collection

**BEST
PRICE**

STANDARD OPTIONS

- » door leaf painted with acrylic UV varnish
- » door leaf frame made of MDF
- » core made of „honeycomb“
- » glass pane white bark 4 mm thick

OPTIONS WITHOUT EXTRA CHARGE

- » glass pane „chinchila“ or „window blind“
- » ventilation sleeves
- » three hinges - applies to rebated door leaf

NOTE: To ensure highest quality of painted products, before painting process, both, door leaf and door frames are coated with special material which constitutes solid base.

REBATED DOOR LEAF

- » straight edge, flat glass pane frame **fig. 1**
- » 2 silver screw-in pivot hinges
- » single-point mortise simple key lock, for bathroom lock, for cylinder lock or economic lock

NON-REBATED DOOR LEAF (extra charge)

- » edge without rebate, flat glass pane frame **fig. 2**
- » sockets for 2 hidden recessed Estetic 80 hinges (hinges constitute a part of the door frame)
- » magnetic simple key lock, bathroom lock, cylinder insert lock or economic magnetic lock in steel, black or white colour

SLIDING DOOR LEAF

- » edge without rebate, flat glass pane frame **fig. 2**
- » socket for hook lock and/or for handles

INVERTED REBATE DOOR LEAF (EXTRA CHARGE)

- » active single leaf door
- » straight edge **fig. 3**
- » sockets for two recessed Estetic 1821 hinges (hinges constitute a part of the door frame)
- » magnetic simple key lock, bathroom lock, cylinder lock, economic lock

OPTIONS AVAILABLE WITH EXTRA CHARGE

- » glass pane MAT DRE, DECORMAT BROWN, DECORMAT GRAPHITE BINITO 11, 23
BINITO 21, 100
BINITO 24, 110
- » white frost VSG 22,1 safe, complex glass pane
BINITO 11
BINITO 23
BINITO 21, 100
BINITO 24
BINITO 110
- » door leaf "90" and "100"
- » tubular chipboard
- » core made of full chipboard
- » non-rebated door leaf
- » ventilation undercut
- » door leaf with inverted rebate
- » cover strip for double leaf non-rebated door
- » plastic ventilation grille
- » aluminum ventilation grille
- » double leaf door leaf price x2
- » **NOTE:** third Estetic 80 hinge for non-rebated doors (extra charge is added to the price of the door frame)

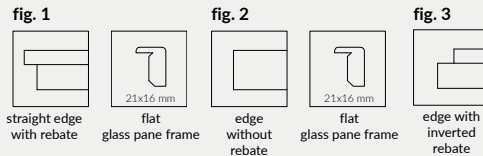

* Note: selected configurations of BINITO 20 model are available as stock orders, rebated in white matt.





BULAJ INVEST metal - honey oak

1st group CPL laminate	milky white	white	ashen							
	dark gray	concrete 2	gray oak	welsh oak	acacia	celini walnut	walnut	honey oak	chestnut	roasted walnut
	riviera oak	rustic oak								

STANDARD OPTIONS

- » door leaf frame made of MDF
- » core made of „honeycomb“
- » transparent glass, 4 mm thickness

OPTIONS WITHOUT EXTRA CHARGE

- » ventilation sleeves
- » three hinges - applies to rebated door leaf

REBATED DOOR LEAF

- » straight edge or edge with radius R 2,5 mm made in directforming fig 1 (rounded glass pane frame in CPL laminate)
- » straight edge fig. 2 (Slim glass pane frame in Finish foils)
- » 2 silver screw-in pivot hinges
- » single-point mortise simple key lock, for bathroom lock, for cylinder lock or economic lock
- » **All orders in the investment standard require approval of the Investment Department. The investment standard, is defined by door frame passage, with opened door leaf at 90 degree, respectively for interior doors: „80“ 800 mm, „90“ 900 mm.**

OPTIONS AVAILABLE WITH EXTRA CHARGE

- » glass pane MAT DRE (applies to door leaf) STANDARD INVEST 20, 70, 80, BULAJ MDF STANDARD INVEST 60
- » core made of tubular chipboard
- » door leaf „100“
- » ventilation undercut
- » plastic ventilation grille
- » aluminum ventilation grille
- » there is possibility to purchase steel BULAJ separately in black or steel colour

fig. 1

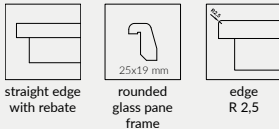
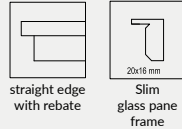

fig. 2



STANDARD INVEST 10

STANDARD INVEST 20

STANDARD INVEST 60

STANDARD INVEST 70

STANDARD INVEST 80

MDF BULAJ INVEST

steel BULAJ INVEST



black steel Bulaj *



steel Bulaj *



R 2,5 mm edge

* only MATT or transparent glass pane available

STANDARD OPTIONS

- » edge with radius R 2,5 mm used in 0,15-0,20 mm CPL laminates
- » straight edge for laminates 0,15-0,20 mm and 0,7 mm
- » door leaf frame made of softwood
- » core made of „honeycomb“
- » glass pane white bark 4 mm thick
- » CPL laminate 0,15 - 0,2 mm or 0,7 mm thick

OPTIONS WITHOUT EXTRA CHARGE

- » glass pane „chinchila“ or „window blind“
- » ventilation sleeves
- » three hinges - applies to rebated door leaf

REBATED DOOR LEAF

- » straight edge or edge with R 2,5 mm radius made by directforming for 0,15-0,20 mm laminates **fig. 1**
- » straight edge for laminates 0,7 mm **fig.1**
- » 2 silver screw-in pivot hinges
- » single-point mortise simple key lock, for bathroom lock, for cylinder lock or economic lock
- » **All orders in the investment standard require approval of the Investment Department. The investment standard, is defined by door frame passage, with opened door leaf at 90 degree, respectively for interior doors: „80“ 800 mm, „90“ 900 mm.**

NON-REBATED DOOR LEAF (extra charge)

- » edge without rebate, rounded glass pane frame **fig. 2**
- » sockets for 2 hidden recessed Estetic 80 hinges (hinges constitute a part of the door frame)
- » magnetic simple key lock, bathroom lock, cylinder lock, economic lock

SLIDING DOOR LEAF

- » edge without rebate, rounded glass pane frame **fig. 2**
- » socket for hook lock and/or for handles

NOTE: colours equivalent: W0118 - WHITE

OPTIONS AVAILABLE WITH EXTRA CHARGE

- » glass pane MAT DRE, DECORMAT BROWN, DECORMAT GRAPHITE (applies to door leaf)
STANDARD 20, BULAJ MDF
STANDARD 60
- » white frost VSG 22,1 safe, complex glass pane
STANDARD 20
STANDARD 60
MDF porthole
- » core made of tubular chipboard
- » "100" door leaves
- » door leaf "110" (available only in STANDARD 10)
- » non-rebated door leaf
- » Additional upper single point mortise lock (available only in STANDARD 10 door leaf model with core made of tubular chipboard and fixed door frame)
- » plastic ventilation grille
- » aluminum ventilation grille
- » cover strip for non-rebated double leaf door
- » ventilation undercut
- » double leaf door leaf price x2
- » there is possibility to purchase steel BULAJ separately in black or steel colour
- » **NOTE:** third Estetic 80 hinge for non-rebated doors (extra charge is added to the price of the door frame)

CPL 0,7 mm laminate is also available in Standard CPL 20, 60, MDF porthole, metal porthole - to place an order, please contact the Customer Service Department.

fig. 1



straight edge with rebate



25x19 mm
rounded glass pane frame



edge R 2,5

fig. 2



edge without rebate



25x19 mm
rounded glass pane frame



STANDARD 10

STANDARD 20

STANDARD 60

BULAJ MDF

steel BULAJ



steel or black steel BULAJ
(available only MATT or transparent glass pane)



R 2,5 mm edge

1st group CPL laminate

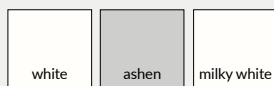

2 group CPL Laminate



STANDARD OPTIONS

- » door leaf frame made of softwood
- » core made of „honeycomb“

OPTIONS WITHOUT EXTRA CHARGE

- » ventilation sleeves

REBATED DOOR LEAF

- » straight edge coated with edge banding or edge with profile R 2,5 mm made in method of directforming **fig. 1**
- » 3 silver screw-in pivot hinges
- » single-point mortise simple key lock, for bathroom lock, for cylinder lock or economic lock

NON-REBATED DOOR LEAF (extra charge)

- » edge without rebate **fig. 2**
- » sockets for 2 hidden recessed Estetic 80 hinges (hinges constitute a part of the door frame)
- » magnetic simple key lock, bathroom lock, cylinder lock, economic lock

OPTIONS AVAILABLE WITH EXTRA CHARGE

- » core made of: perforated chipboard (1983) perforated
- » chipboard (2110 and 2240)
- » door leaf "90" - "100" (1983) DRE - CELL
- » door leaf "90" - "100" (2110 and 2240) DRE - CELL
- » door leaf "90" - "100" (1983) DRE - CELL
- » door leaf "100" (2110 and 2240) DRE - CPL
- » non-rebated door leaf
- » ventilation undercut
- » plastic ventilation grille
- » aluminum ventilation grille
- » cover strip for double leaf non-rebated door
- » double leaf door leaf price x2
- » **NOTE:** third Estetic 80 hinge for non-rebated doors (extra charge is added to the price of the door frame)

There is available 0,7 mm CPL laminate- to place an order and for more information please contact Customer Service Department.

Door leaf, dependent on selected height option - 1983 mm, 2110 mm or 2240 mm is dedicated to door frames with three hinges in corresponding heights.

NOTE: colours equivalent: W0118 - WHITE

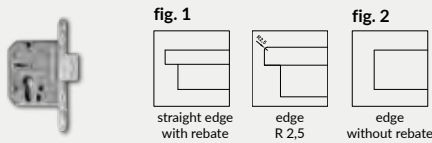

additional upper single point mortise lock (available only in STANDARD 10 door leaf model with core made of perforated chipboard and fixed door frame)

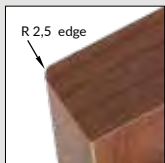

R 2,5 mm edge in CPL laminate



white matt	white pine	siberian elm	silver	sand oak	bleached oak textured	vintage oak	caramel walnut	golden oak textured	dark walnut textured	gray oak textured***	tabac elm	anthracite elm	dark wenge	Decor DRE-Cell
					marrone chestnut textured	gray textured	black textured	toffee oak***	evoked oak	light gray matt	white (textured)	walnut		
*** decor available only in horizontal graining													1st group CPL laminate	
*while stock last														
dark gray	concrete 2	gray oak	welsh oak	acacia	celini walnut	walnut	honey oak	chestnut	roasted walnut					2 group CPL Laminate

STANDARD OPTIONS

- » door leaf frame made of softwood
- » core made of „honeycomb”
- » glass pane white bark 4 mm thick

OPTIONS WITHOUT EXTRA CHARGE

- » glass pane „chinchila” or „window blind”
- » ventilation sleeves

REBATED DOOR LEAF

- » straight edge, flat glass pane frame (in CPL laminate - rounded glass pane frame) flat 4 mm HDF panels **fig. 1**
- » 3 silver screw-in pivot hinges
- » single-point mortise simple key lock, for bathroom lock, for cylinder lock or economic lock

NON-REBATED DOOR LEAF (extra charge)

- » edge without rebate, flat glass pane frame (in CPL - rounded glass pane frame), flat 4 mm HDF panels **fig. 2**
- » sockets for 2 hidden recessed Estetic 80 hinges (hinges constitute a part of the door frame)
- » magnetic simple key lock, bathroom lock, cylinder lock, economic lock

NOTE: colours equivalent: W0118 - WHITE

NOTE: In rebated door leaf coated with CPL laminate it is possible to choose door leaf with edge with radius R=2,5 mm.

NOTE: Different heights are available in all models of MODERN collection.

Door leaf, dependent on selected height option - 1983 mm, 2110 mm or 2240 mm is dedicated to door frames with three hinges in corresponding heights.

OPTIONS AVAILABLE WITH EXTRA CHARGE

- » glass pane MAT DRE, DECORMAT BROWN, DECORMAT GRAPHITE (applies to door leaf) MODERN 20
MODERN 30
MODERN 40
MODERN 50
- » white frost VSG 22,1 safe, complex glass pane p. 73
- » core made of: perforated chipboard (1983 and 2043)
- » perforated chipboard (2110 and 2240)
- » door leaf „90” and „100” (1983 and 2043)
- » door leaf "90" and "100" (2110 and 2240)
- » non-rebated door leaf
- » ventilation undercut
- » plastic ventilation grille
- » aluminum ventilation grille
- » cover strip for double leaf non-rebated door
- » double leaf door leaf price x2
- » NOTE: third Estetic 80 hinge for non-rebated doors (extra charge is added to the price of the door frame)
- NOTE: collection MODERN 10-50 coated with CPL laminate in standard height is available in sliding version.

fig. 1

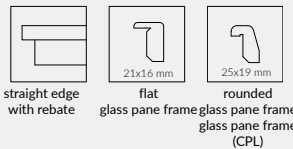
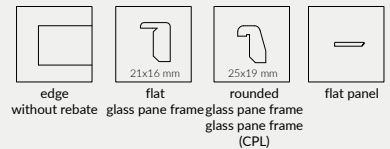

fig. 2



198 MODERN 30

standard height

211 MODERN 30

224 MODERN 30

Decor DRE-Cell	white matt	white pine	siberian elm	silver	sand oak	bleached oak textured	vintage oak	caramel walnut	golden oak textured	dark walnut textured	gray oak textured***	tabac elm	evoke oak	light gray matt
	white (textured)	walnut	marrone chestnut textured	gray textured	black textured	toffee oak	anthracite elm	dark wenge						
CPL Laminate	white	milky white	ashen	dark gray	concrete 2	gray oak	welsh oak	acacia	celini walnut	walnut	honey oak	chestnut	roasted walnut	

*** decor available only in horizontal graining * decor available while stocks last

STANDARD OPTIONS

- » door leaf frame made of softwood
- » core made of „honeycomb“
- » glass pane white bark 4 mm thick

OPTIONS WITHOUT EXTRA CHARGE

- » glass pane „chinchila“ or „window blind“
- » ventilation sleeves

REBATED DOOR LEAF

- » straight edge, flat glass pane frame (in CPL laminate - rounded glass pane frame) flat 4 mm HDF panels **fig. 1**
- » 3 silver screw-in pivot hinges
- » single-point mortise simple key lock, for bathroom lock, for cylinder lock or economic lock

NON-REBATED DOOR LEAF (extra charge)

- » edge without rebate, flat glass pane frame (in CPL laminate - rounded glass pane frame), flat 4mm HDF panels **fig. 2**
- » sockets for 2 hidden recessed Estetic 80 hinges (hinges constitute a part of the door frame)
- » magnetic simple key lock, bathroom lock, cylinder lock, economic lock

NOTE: colours equivalent: W0118 - WHITE

NOTE: In rebated door leaf coated with CPL laminate it is possible to choose door leaf with edge with radius R=2,5 mm.

NOTE: Different heights are available in all models of PLUS collection.

Door leaf, dependent on selected height option - 1983 mm, 2110 mm or 2240 mm is dedicated to door frames with three hinges in corresponding heights.

OPTIONS AVAILABLE WITH EXTRA CHARGE

- » glass pane MAT DRE, DECORMAT BROWN, DECORMAT GRAPHITE (applies to door leaf) PLUS 20 PLUS 40, 50, 60, 70, 80 PLUS 30
- » white frost VSG 22,1 safe, complex glass pane p. 77
- » core made of: perforated chipboard (1983 and 2043)
- » perforated chipboard (2110 and 2240)
- » door leaf „90“ and „100“ (1983 and 2043)
- » door leaf "90" and "100" (2110 and 2240)
- » non-rebated door leaf
- » ventilation undercut
- » plastic ventilation grille
- » aluminum ventilation grille
- » cover strip for double leaf non-rebated door
- » double leaf door leaf price x2
- » NOTE: third Estetic 80 hinge for non-rebated doors (extra charge is added to the price of the door frame)

NOTE: collection PLUS 10-80 coated with CPL laminate in standard height is available in sliding version.

fig. 1

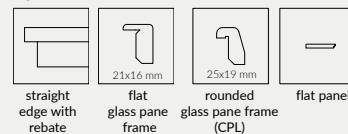
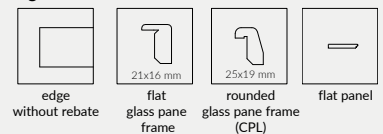

fig. 2



198 PLUS 30

standard height

211 PLUS 30

224 PLUS 30



* decor available while stocks last *** decor only in horizontal graining



ENA - white matt

DRE sliding system is designed to be used together in one set with single or double leaf door, which are available in our sales offer in sliding version. Sliding system is available in colours which constitute standard finishing colours of door leaf unit: DRE - Cell, 3D foil, CPL laminates, and painted doors with the exception of the following collections: Enter, Enter Akustic, Solid, Solid RC2, Forca B, fire resistant doors, glass doors, and doors with different heights.

In our sale offer there are available two different types of sliding system:

NS - system mounted directly on the wall

NT - sliding system mounted together with adjustable tunnel

There are two options of NT sliding system:

- » mounted together with adjustable tunnel with 63 mm architrave
- » mounted together with adjustable tunnel with 80 mm architrave

Set of sliding system comprises of: sliding guide bar with hardware (LEON SN 150, 180, 200), spacing board, masking strip, and fender beam (fender beam is available for single leaf - for doors with hook lock option in fender beam there is milling for latch).

In the system mounted with adjustable tunnel, NT, set contains 2 additional 16 mm spacing boards with cross-sections adapted to the width of architraves (63 mm or 80 mm). There are differences in cross-sections of NS and NT masking element.

To complete entire set of sliding doors it is necessary to purchase sliding leaf unit in following dimensions:

Single leaf door: „60“, „70“, „80“, „90“, „100“

Double leaf door: „2x60“, „2x70“, „2x80“, „2x90“, „2x100“

Door leaf might be equipped with sockets for lock and/or handle - those accessories must be purchased separately.

In the system mounted with adjustable tunnel NT, it is necessary to purchase adjustable tunnel separately.

SLIDING SYSTEM

WALL MOUNTED SLIDING SYSTEM

ACCESSORIES



- » round handle 1 pcs.
- » oval handle 1 pcs.
- » Hook lock with the key with two round or oval handles
- » hook lock with toilet option with two round or oval handles
- » hook lock with cylinder lock insert with two round handles
- » One set of door handle for single leaf door consist of 2 pcs.

masking strip with guide bar

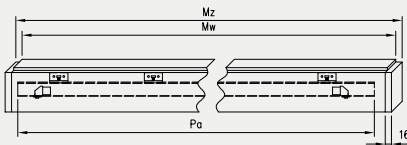

Masking strip and guide bar for double sliding system is made by connecting two elements of single system.



hook lock with a key and a round handle
hook lock with key and oval handle

Single sliding system

Dimension door [mm]	Masking strip		Guide bar
	Mz	Mw	Pa
644, 744	1620	1588	1500
844	1920	1888	1800
944	2120	2088	2000
1044	2160	2128	2000

double leaf door sliding system

Dimension door [mm]	Masking strip		Guide bar
	Mz	Mw	Pa
2 x 644	2 x 1519	2 x 1503	2 x 1500
2 x 744	2 x 1519	2 x 1503	2 x 1500
2 x 844	2 x 1819	2 x 1803	2 x 1800
2 x 944	2 x 2019	2 x 2003	2 x 2000
2 x 1044	2 x 2063	2 x 2047	2 x 2000

NS - vertical cross-section

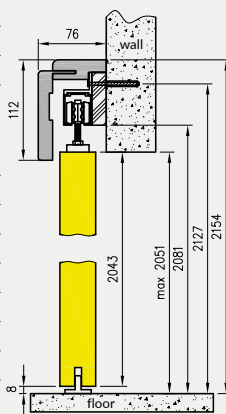

NT - vertical cross-section for tunnel with 63 mm architrave

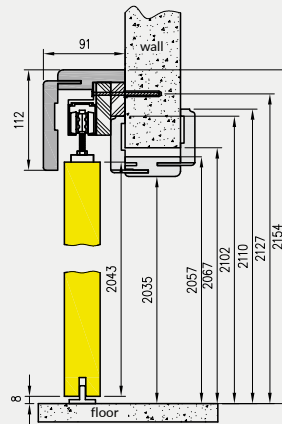

NT - vertical cross-section for tunnel with 80 mm architrave

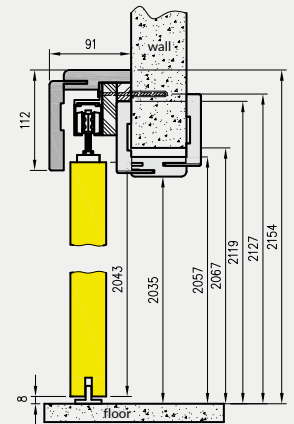

Height of sliding door leaf unit - 2043 mm
total height of sliding system - 2154 mm

Single sliding system

symbol	"60"	"70"	"80"	"90"	"100"
A	602	702	802	902	1002
C	646	746	846	946	1046
D	664	764	864	964	1064
E	752	852	952	1052	1152
E*	786	886	986	1086	1186
S	644	744	844	944	1044

double leaf door sliding system

symbol	"120"	"140"	"160"	"180"	"200"
A	1200	1400	1600	1800	2000
C	1244	1444	1644	1844	2044
D	1264	1464	1664	1864	2064
E	1350	1550	1750	1950	2150
E*	1384	1584	1784	1984	2184
S**	644	744	844	944	1044

E* applies to tunnel with T80 architrave
S** width of single leaf door

NS - horizontal cross-section (left system)

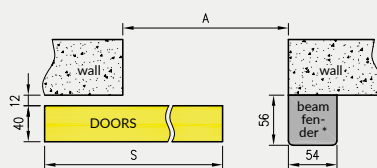

NT - horizontal cross-section (left system)

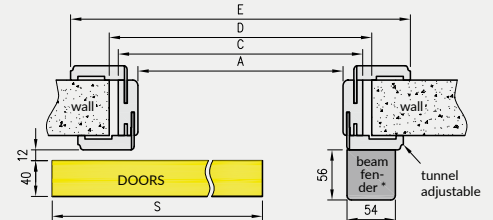

* is not available in double leaf system

NOTE: In double sliding system masking strip is connected by two single elements.



GALLA 1 decormat

Sliding system for glass doors "Spazio", is made of anodized aluminum, and used as a complete and complementary solution together with finished door frame. Whole set comprises of - guide channel with straight or oval blende, hardware designed to hang sliding glass pane and bottom door guide.

There are two options of Spazio System (only difference is in the shape of external blende):

- » Spazio TP - with straight blende
- » Spazio TO - with oval blende

To complete the whole system it is recommended to buy glass door leaf in sliding version from collection Galla collection and a round handle.

OPTIONS AVAILABLE WITH EXTRA CHARGE

- » door handle (two-sided)



door handle
(stainless steel)

Note: There is no possibility to make ventilation option.

sliding glass door leaf

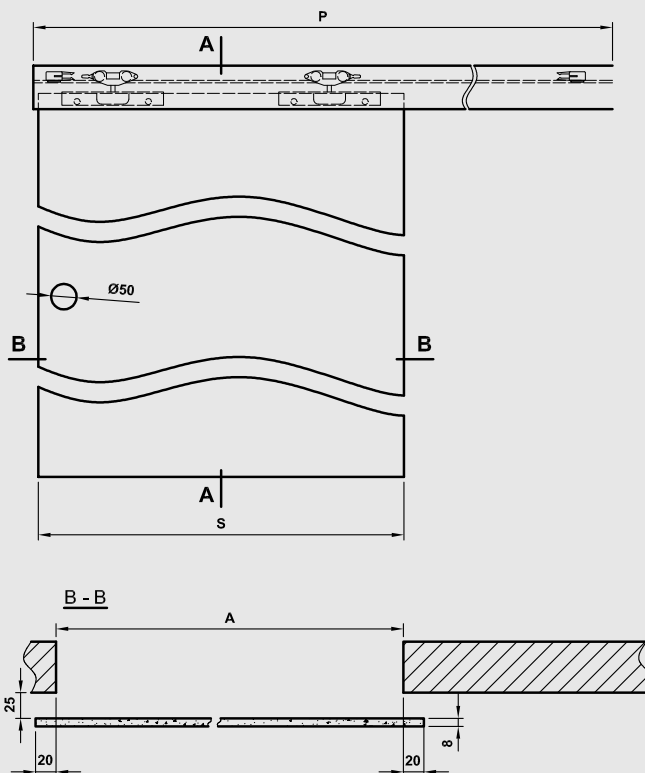
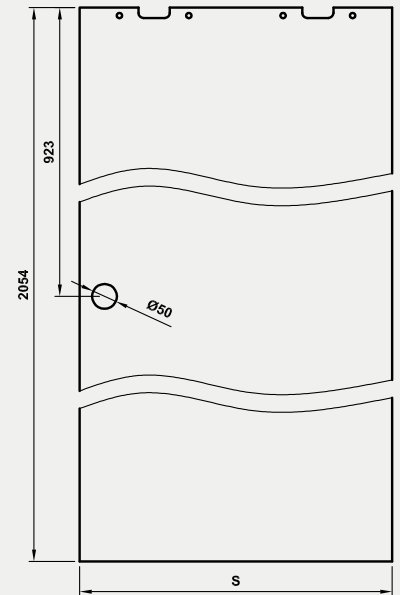

A - A vertical cross-section of Spazio TP

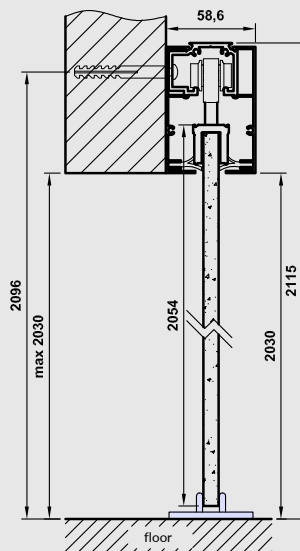

A - A vertical cross-section of Spazio TO

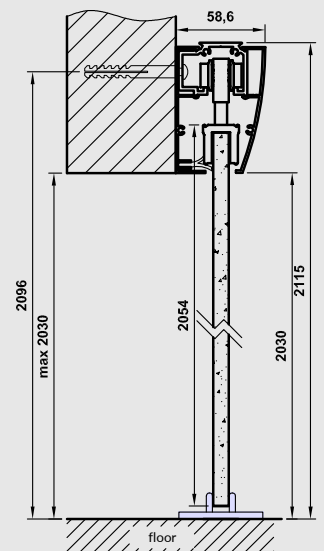

Dimensions

	S	A	P
"60"	630	590	1340
"70"	730	690	1540
"80"	830	790	1740
"90"	930	890	1940

S - width of door leaf unit
A - width of wall passage
P - length of guide channel



Sliding system SPAZIO CD - STANDARD 10 sand oak

SLIDING SYSTEM SPAZIO CD MOUNTED ON-WALL

SLIDING SYSTEM DOOR LEAF
interior door leaves

SPAZIO CD

On-wall mounted sliding system with anodized guide channel and rectangular blende. Is designated for panel doors and frame construction doors.

WHOLE SET COMPRISES OF:

- » guide channel with side caps
- » system sliding trolleys
- » door leaf hangers
- » bottom stopper
- » assembly kit (screws and bolts)

To complete the whole system it is recommended to buy door leaf in sliding system version available in our standard sale offer together with door handle. Door handle is to be purchased separately (informations p.97).

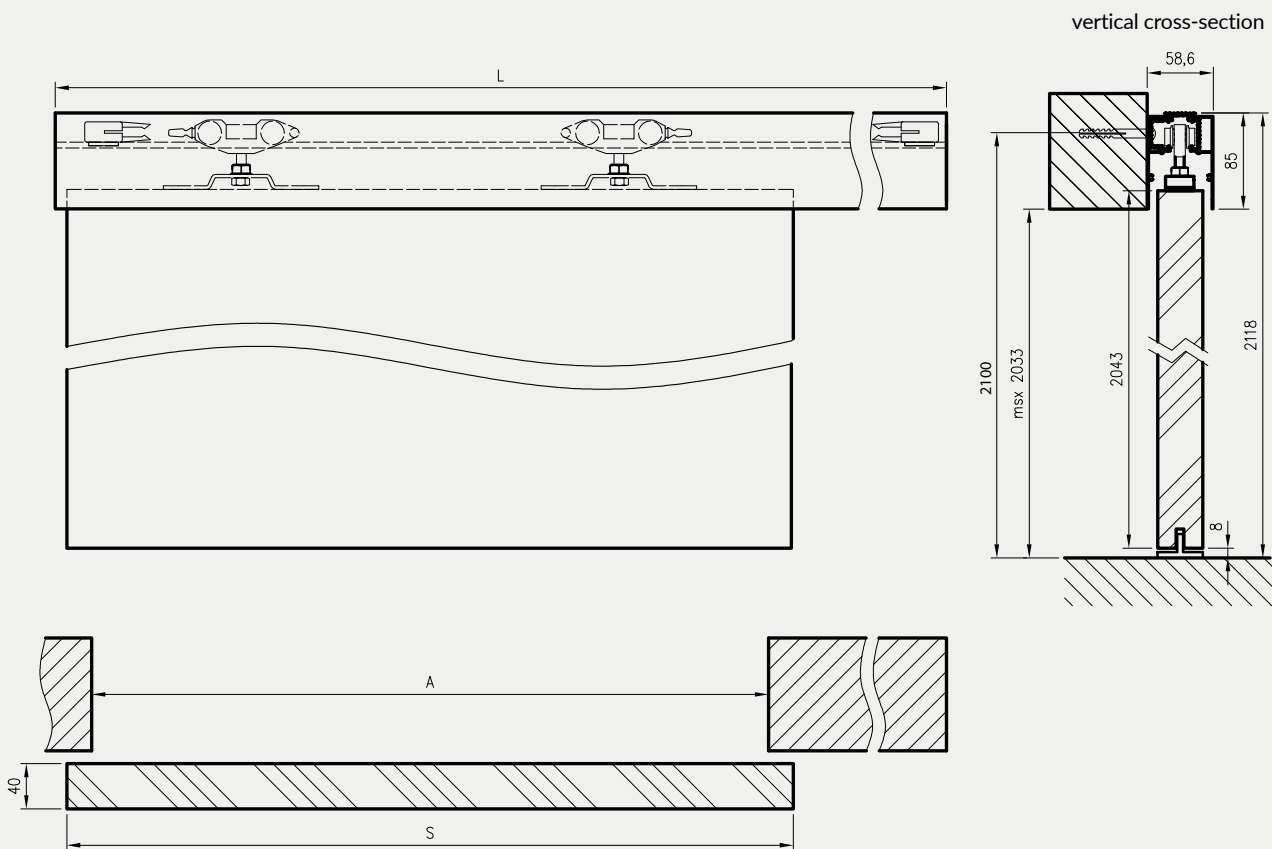

	A	S	L
"60"	600	644	1370
"70"	700	744	1570
"80"	800	844	1770
"90"	900	944	1970
"100"	1000	1044	2170

A - width of wall passage
S - width of door leaf unit
L - lenght of guide channel



Sliding system doors hidden in the wall (pocket system) PA - STANDARD 10 vintage oak

Decor DRE-Cell	white (textured)	white matt	white pine	siberian elm	silver	evoke oak	vintage oak	sand oak	bleached oak textured	walnut	caramel walnut	golden oak textured
	dark walnut textured	gray oak textured***	tabac elm	anthracite elm	dark wenge	gray textured	black textured	toffee oak***	marrone chestnut textured	antique copper	oxide concrete	black matt 2
	light gray matt	dark olive matt	dark blue matt									

Decor 3D	grand oak	elm	american walnut	ebony*	Polish oak 3D
-----------------	-----------	-----	-----------------	--------	---------------

*** decor available only in horizontal wood grain

*while stock last

Decor painted	white	ecru	latte	ashen
----------------------	-------	------	-------	-------

white acrylic UV varnish - RAL 9003
 ecru - RAL 9001
 latte - Flugger 4362, NCS S1505-Y50R
 ashen - RAL 7035

SLIDING SYSTEM DOORS HIDDEN IN THE WALL (POCKET SYSTEM)

SLIDING SYSTEM DOOR LEAF
interior door leaves

PA DOOR FRAME CASSETTE

System assembly involves embedding the cassette in the construction of profiles used to build a plasterboard wall (or other construction) with a thickness of:

- » 100 mm for the PA 100 mm door frame cassette
- » 125 mm for the PA 125 mm door frame cassette

Next, wide surfaces construction with the usage of 12,5 mm plasterboards (plasterboards must be purchased separately) and finishing these surfaces and assembly of Tunnel Cassette Cover.

NOTE: VETRO A, VETRO D and VETRO B door leaf with a width of "70" do not fit the 100 mm and 125 mm PA cassettes.

In addition, the 100 mm PA cassettes cannot be used with door leaves with locks and panel construction doors with glazing or panels

THE SET INCLUDES:

- » cassette elements made of aluminum elements and accessories for its assembly
- » elements that allow for decorative built-up jambs - so called Tunnel Cassette Cover with the architraves 80mm width

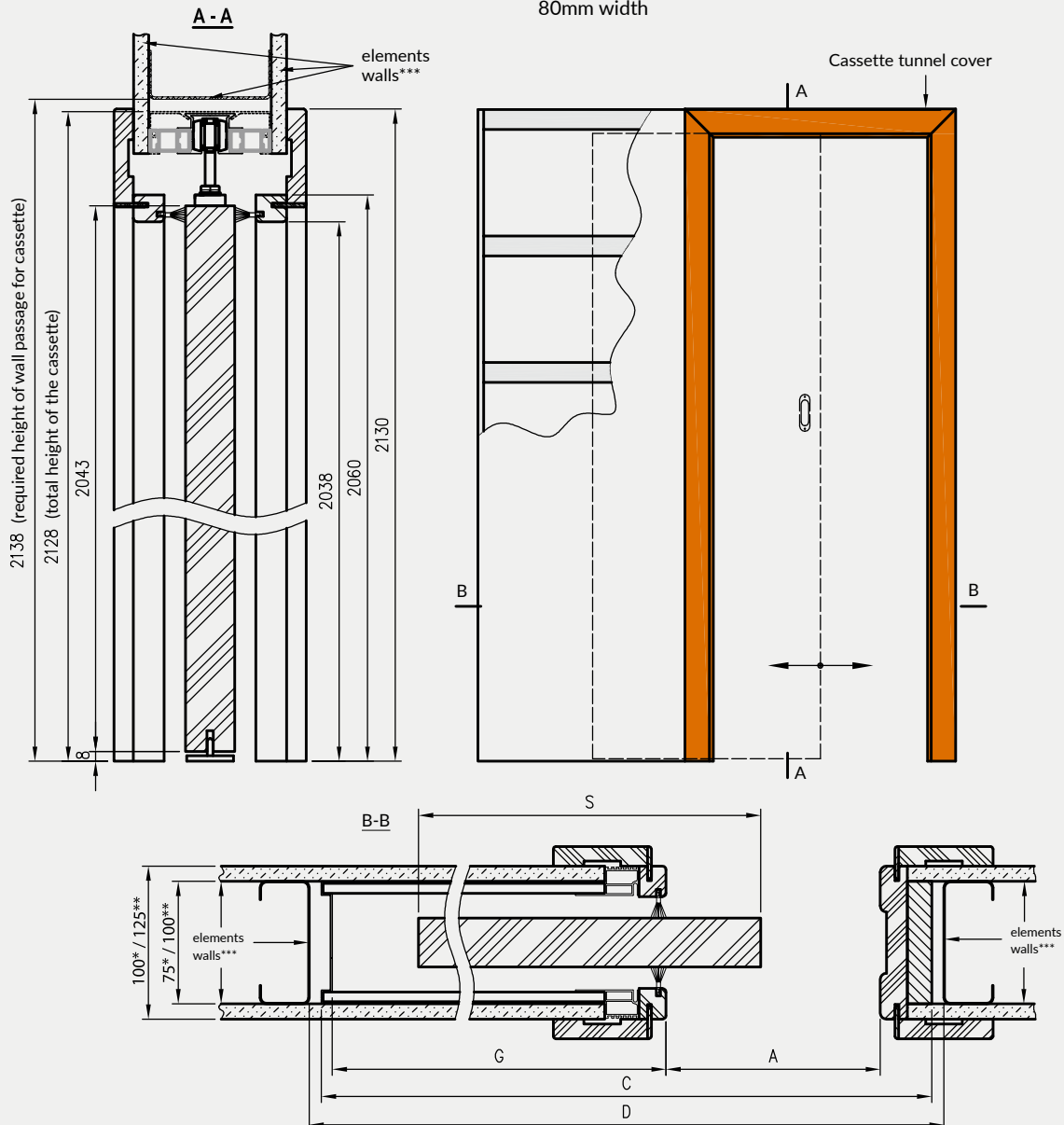

	A	S	C	D	G
60	600	644	1310	1330	656
70	700	744	1510	1530	756
80	800	844	1710	1730	856
90	900	944	1910	1930	956
100	1000	1044	2110	2130	1056

* dimensions refer to the 100mm PA cassette

** dimensions refer to 125mm PA cassette

*** wall elements are not components of the product

C - total width of cassette

D - width of walls passage prepared for cassette

G - depth of ready cassette



folding doors FOLDE 10 - white matt

Decor DRE-Cell														
Decor 3D														

*** decor available only in horizontal wood grain

*while stock last

In folding doors during opening process of door leaf unit, doors fold into position parallel to each other. The complete set of folding doors comprises of:

- » two-elements door leaf connected by 3 hidden recessed hinges
- » adjustable door frame for folding doors

STANDARD OPTIONS

- » door leaf frame made of softwood
- » core made of „honeycomb“
- » straight edge **fig. 1**
- » single-point mortise simple key lock, for bathroom lock, for cylinder lock or economic lock
- » 3 hidden recessed ISTAR hinges installed between two-element of door leaf unit

OPTIONS AVAILABLE WITH EXTRA CHARGE

- » core made of tubular chipboard
- » door leaf "90" and "100"

fig. 1

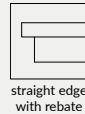

Cross-section of folding doors in closed position*
(right doors, left doors mirror reflection)

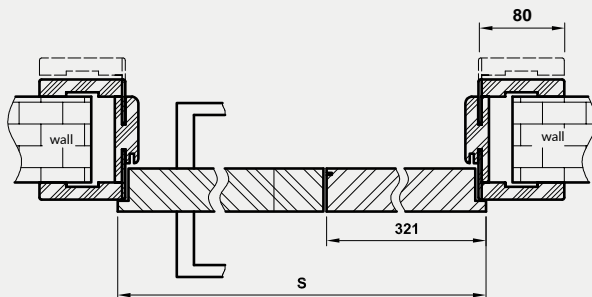

Dimensions

	S	A	B	C	D	E
"80"	844	806	830	850	880	990
"90"	944	906	930	950	980	1090
"100"	1044	1006	1030	1050	1080	1190

D - required width of wall opening

NOTE: There is no possibility to shorten door leaf.

Cross-section of folding doors
in opened position*

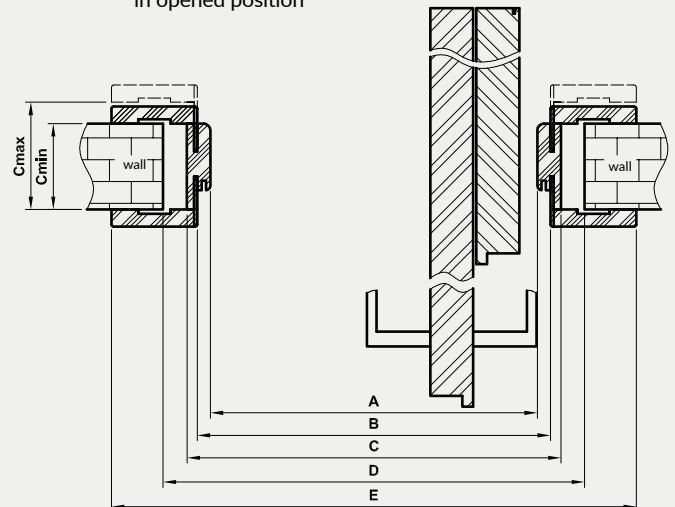

*NOTE: When doors are fully opened, the door fittings slightly reduce the clear opening by approx. 10 cm. (this value doesn't take into account door handle)

vertical cross-section

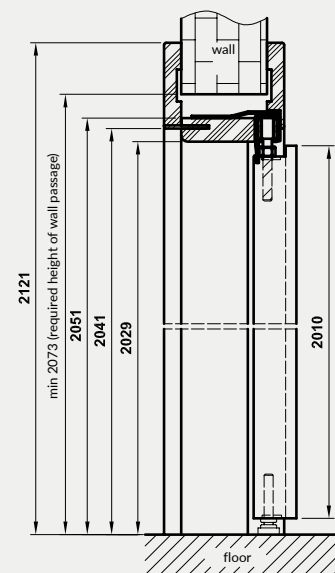



SARA ECO 2 toffee oak

Available colours of aluminum door frames



anode



White
RAL 9003



aluminum

NON-REBATED - OPENING OUTWARDS AND REBATED - OPENING INWARDS

Sara Eco 2 door leaf is an innovative solution for creative interior design with the use of "invisible" doors. This unique construction gives possibility to finish surface of door leaf in the colors of the walls.

CONSTRUCTION OF SARA ECO 2 DOOR LEAF COMPRISES OF:

Aluminum door frame, "invisible" after assembly process, build in the wall or overlaid with sheets of plaster board. After detailing process, the only visible part is rebate of the door frame, prepared for future painting, e.g. in the colours of the walls.

Non- rebated panel construction door leaf is available in two finishing options:

- » wide surfaces of door leaf are primed and ready for painting or paperhanging (e.g. in the colour of the walls). Edges of the leaf are covered with a paintable edge band. Painting is to be done at one-s discretion or optional choose painted decor.
- » wide surfaces of the door leaf covered with DRE-Cell foils, 3D or foil for painting from the group of painted decors, door leaf edges covered with the edge band in the same color as the foil (except for antique copper and oxide concrete).

OPTIONS AVAILABLE WITH EXTRA CHARGE WITH PRIMER

- » ventilation undercut
- » tubular chipboard in 202 standard
- » tubular chipboard in 220 standard
- » tubular chipboard in 240 standard

STANDARD OPTION

- » door leaf frame made of softwood
- » sockets for 2, 3 or 4 ISTAR recessed hinges
- » core made of „honeycomb“
- » white or silver simple key magnetic lock, toilet lock, cylinder lock or economic lock

OPTIONS AVAILABLE WITH EXTRA CHARGE IN DRE-CELL, 3D AND PAINTED

- » ventilation undercut
- » plastic ventilation grille
- » aluminum ventilation grille
- » dropping seal
- » tubular chipboard in 202 standard
- » tubular chipboard in 220 standard
- » tubular chipboard in 240 standard

The price of the door frame also includes 2, 3 or 4 recessed hinges.
Note: in option with stabilising insert as tubular chipboard, in standard 202 it is required to use 3 hinges.

white (textured)	white matt	white pine	siberian elm	gray textured	silver	sand oak	bleached oak textured	vintage oak	caramel walnut	golden oak textured	Decor DRE-Cell 1 group
light gray matt	evoke oak	walnut	marrone chestnut textured	dark walnut textured	gray oak textured***	tabac elm**	anthracite elm	dark wenge	black textured	toffee oak***	
									antique copper	oxide concrete	Decor DRE-Cell 2 group
						grand oak	elm	american walnut	ebony**	Polish oak 3D	Decor 3D
										primed	Decor
							white	ecru	latte	ashen	Decor painted

white acrylic UV varnish - RAL 9003
ecru - RAL 9001
latte - Flugger 4362, NCS S1505-Y50R
ashen - RAL 7035

* decor with a door leaf edge in black colour
**while stock last
*** decor available only in horizontal wood grain

NON-REBATED - OUTWARD OPENING IN THE 202X, 220X, 240X STANDARD

Horizontal cross-section of non-rebated Sara Eco 2 - opening outwards

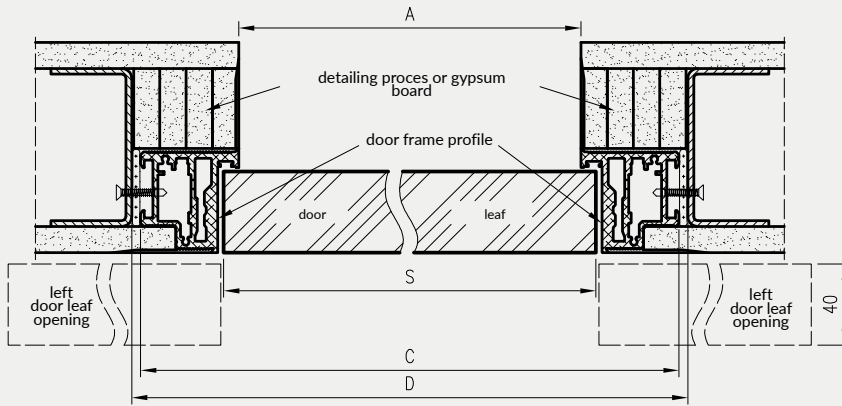

Vertical cross-section of the Sara Eco 2 non-rebated door leaves - opening outwards

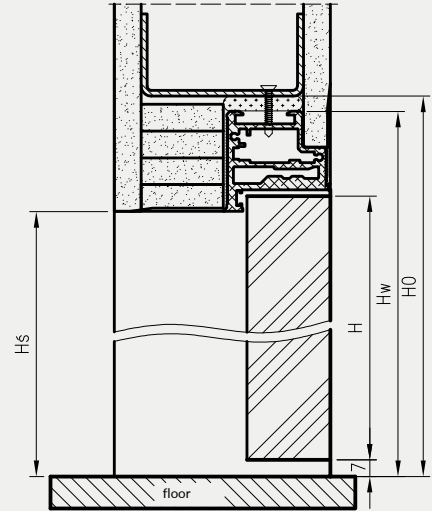

Dimensions of non-rebated door leaves

standard	H	H _s	hw	H ₀
202x	2020	2020	2068	2075
220X	2200	2200	2248	2255
240X	2400	2400	2448	2455

Dimensions of the door leaf width Sara Eco 2

	S	A	C	D
"60"	620	605	701	710
"70"	720	705	801	810
"80"	820	805	901	910
"90"	920	905	1001	1010
"100"	1020	1005	1101	1110

REBATED - INWARD OPENING IN THE 202X, 220X, 240X STANDARD

Cross-section of rebated Sara Eco2 - opening inwards

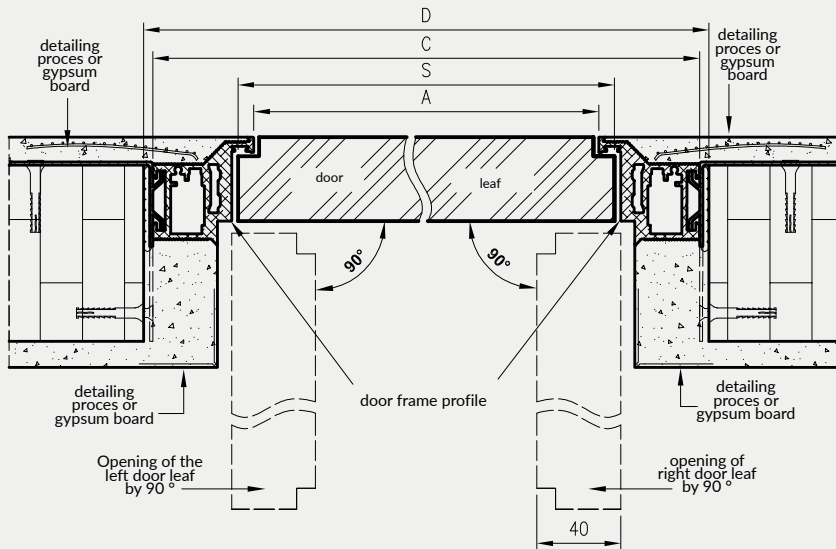

Vertical cross-section of the Sara Eco 2 rebated door - opening inwards

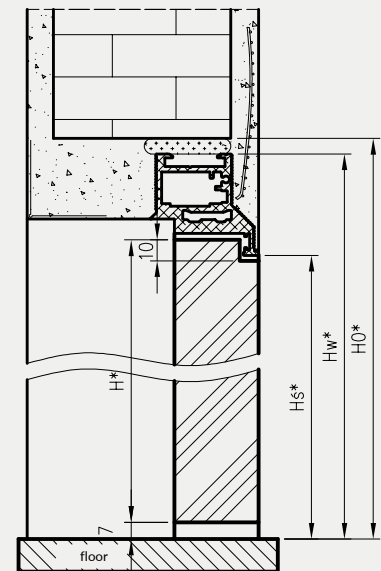

height dimensions of rebated doors

standard	H*	H _s *	Hw*	H ₀ *
202x	2030	2030	2078	2085
220X	2210	2210	2258	2265
240X	2410	2410	2458	2465

Dimensions of the door leaf width Sara Eco 2

	S	A	C	D
"60"	620	605	701	710
"70"	720	705	801	810
"80"	820	805	901	910
"90"	920	905	1001	1010
"100"	1020	1005	1101	1110

- S - door leaf width
- A - width of passage in door frame unit
- C - external width of door frame
- D - required width of wall opening
- H - the height of the door leaf
- H_s - height of the door frame passage
- Hw - external height of the door frame
- H₀ - height of the wall passage

* - Applies to rebated doors

NON-REBATED - OUTWARD OPENING IN THE 202X STANDARD

Horizontal cross-section of the Sara Eco 2 non-rebated door - opening outwards

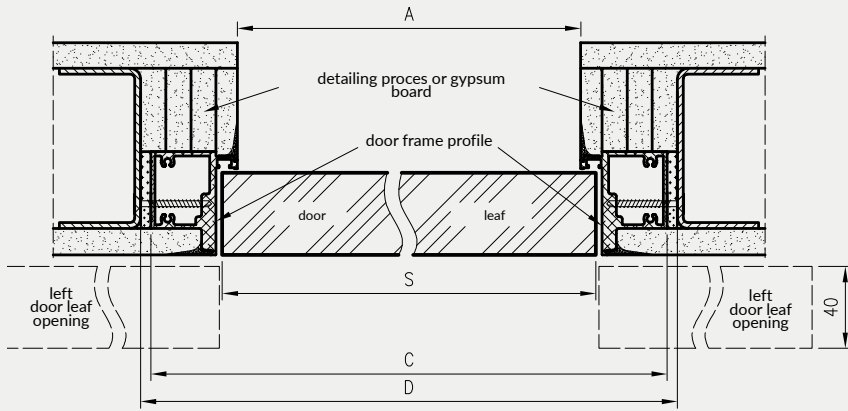

Vertical cross-section of the Sara Eco 2 non-rebated door leaves - opening outwards

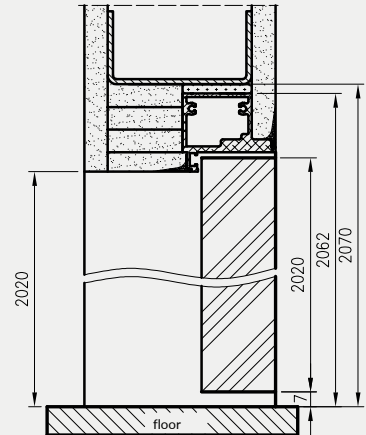

Dimensions of the door leaf width Sara Eco 2

	S	A	C	D
"60"	620	605	690	700
"70"	720	705	790	800
"80"	820	805	890	900
"90"	920	905	990	1000
"100"	1020	1005	1090	1100

REBATED - INWARD OPENING IN THE 202X STANDARD, DRE DOOR FRAME

Cross-section of the Sara Eco2 rebated door leaf - opening inwards

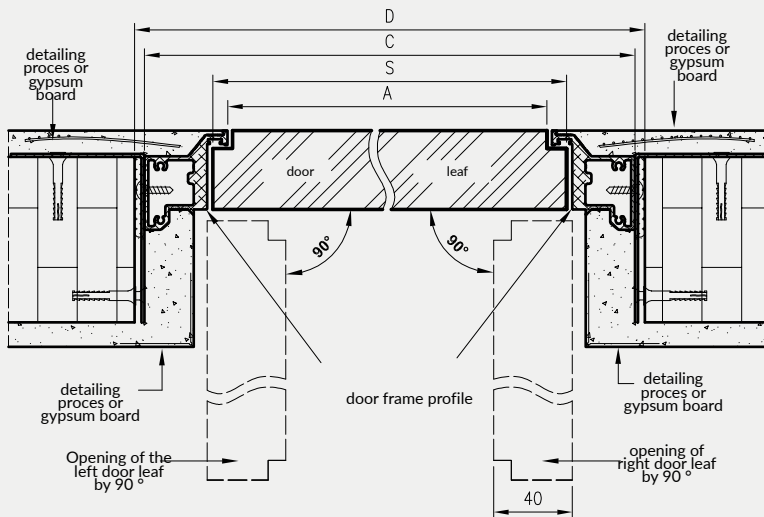

Vertical cross-section of the Sara Eco 2 rebated door leaf - opening inwards

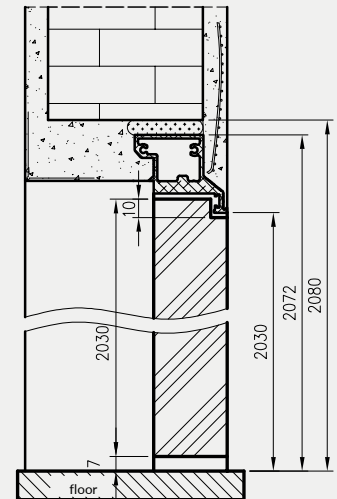

Dimensions of the door leaf width Sara Eco 2

	S	A	C	D
"60"	620	605	690	700
"70"	720	705	790	800
"80"	820	805	890	900
"90"	920	905	990	1000
"100"	1020	1005	1090	1100

S - door leaf width
A - width of passage in door frame unit
C - external width of door frame
D - required width of wall opening

STANDARD OPTIONS

- » door leaf frame made of softwood
- » core made of „honeycomb“
- » glass pane 4 mm thickness: white bark, "window blind", CHINCHILA, MAT DRE, DECORMAT BROWN or DECORMAT GRAPHITE.
- » 2 silver screw-in pivot hinges
- » latch strike plate and two flush bolts
- » options: straight edge *, flat glass pane frame or black Slim glass pane frame fig. 1

OPTION WITHOUT EXTRA CHARGE

- » three hinges option applies to rebated door leaf
- » black glass pane frame Slim

OPTIONS AVAILABLE WITH EXTRA CHARGE

- » white frost VSG 22,1 safe, complex glass pane DOSTAWKA 30 EXTRA 40 EXTRA 41
- » core made of tubular chipboard
- » door frame for door leaf with side panel

+30%

Side panel it is passive rebated door leaf unit with "40" width and 40 mm thick, with glazing or without glazing option, in uniform wood grain. Side panels can be paired with interior rebated door leaf in the following combination: „60+40“; „70+40“; „80+40“; „90+40“; „100+40“.

Side panel 10 can be applied to rebated interior door leaf. Side panel 30 can be applied to models ARTE 10-30 and STANDARD 30 Side panel 40 can be applied to models ARTE 40, 50, 90; STANDARD 40, KANON 30, DECO collection. Side panel 41 can be applied to models MODERN 30, PLUS 30

To make the best possible match of side panel to door leaf unit, besides selection of model, it is necessary to choose wright colour, type of the edge and number of hinges.

NOTE: There is no possibility to shorten side panels.

fig. 1

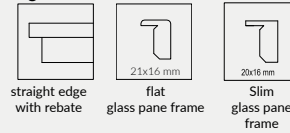

Decor 3D	elm	american walnut	ebony*	Polish oak 3D	grand oak									
Decor DRE Cell	white matt	white pine	siberian elm	silver	sand oak	bleached oak textured	vintage oak	caramel walnut	golden oak textured	dark walnut textured	gray oak textured**	tabac elm	anthracite elm	dark wenge
	gray textured	black textured	toffee oak ***	marrone chestnut textured	evoked oak	light gray matt	white (textured)	walnut	*** decor available only in horizontal wood grain					
									*while stock last					
Laminate CPL	white	milky white	ashen	dark gray	concrete 2	gray oak	welsh oak	acacia	celini walnut	walnut	honey oak	chestnut	roasted walnut	

STANDARD OPTIONS

- » stiles made of wood-based panels
- » glass pane 4 mm: MAT DRE, decormat brown, decormat graphite or transparent glass
- » 3 silver screw-in pivot hinges
- » latch strike plate and two flush bolts
- » straight edge **fig. 1**

fig. 1



OPTIONS AVAILABLE WITH EXTRA CHARGE

- » door frame for door leaf with side panel +30%

NOTE: Price of side panel is equal to the price of corresponding door leaf model.

There is possibility to make side panels to all frame construction door leaf, available in presented collections, in following combinations: „60+40“; „70+40“; „80+40“; „90+40“; „100+40“

NOTE: There is no possibility to shorten side panels.

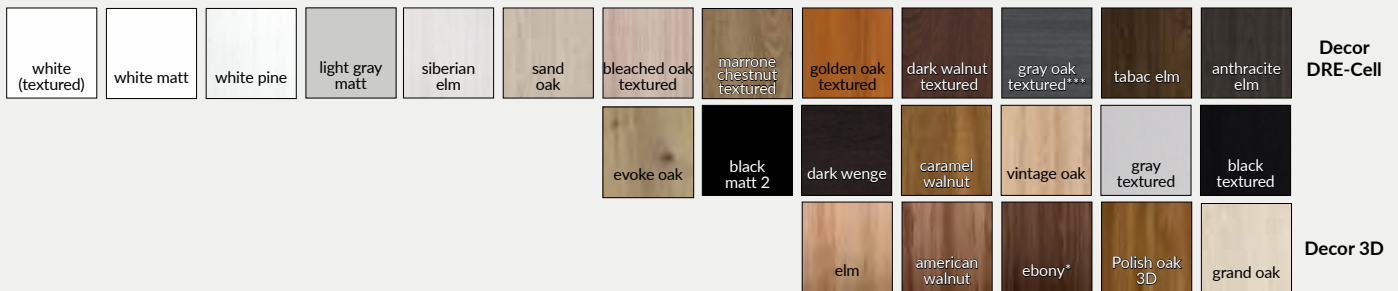
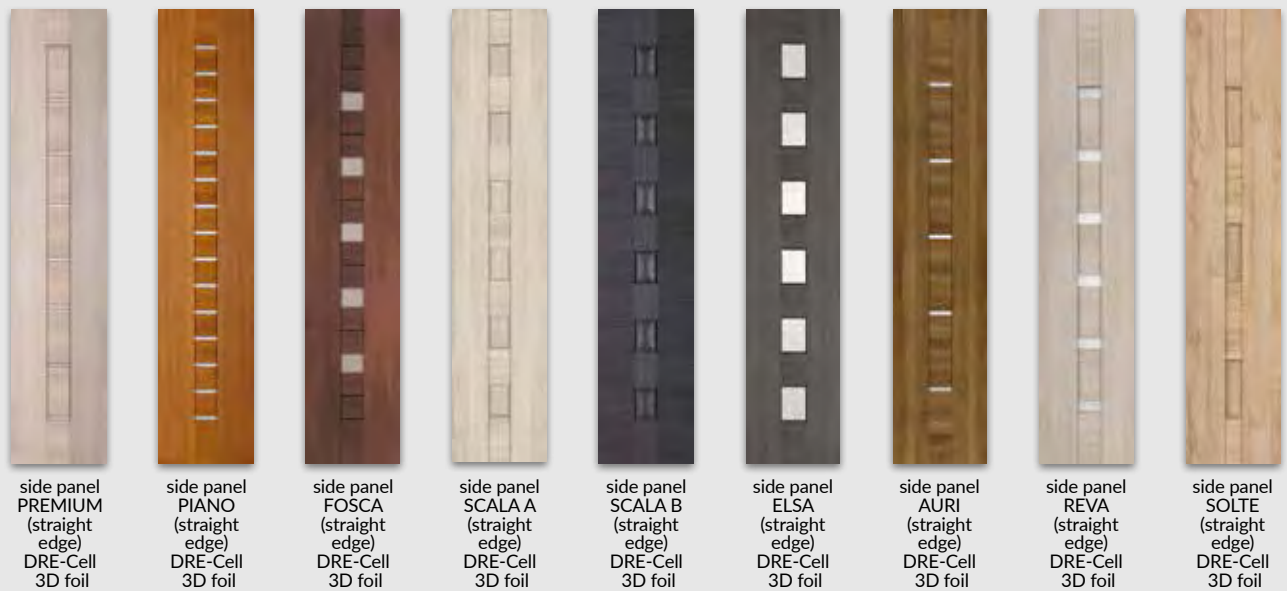

*** decor available only in horizontal wood grain

*while stock last

TRANSOM LIGHTS / SIDELIGHTS



Possible configuration of transom lights/side lights



TRANSOM LIGHTS AND SIDELIGHTS

Transom lights/ sidelights are fixed, unopenable, glazed partition between rooms or spaces that may constitute an independent structure or a supplement for interior doors (except for glass doors) with a fixed door frames. Transom lights/sidelights are manufactured and delivered as a set of components ready for assembly. Set contains the following:

- » two horizontal and two vertical main beams
- » set of cover and installation strips
- » set of gaskets
- » main beam couplers

Transom lights/sidelights are used in interior doors with a fixed door frames and they come in the following decors DRE-Cell, 3D, CPL laminate 0,15-0,20 mm and painted.

NOTE: Our product doesn't come with the glass pane, which should be purchased separately. We recommend to use tempered glass pane with a thickness of 4 mm. Assembly of transom lights/sidelights should be performed once the "wet" construction are completed.

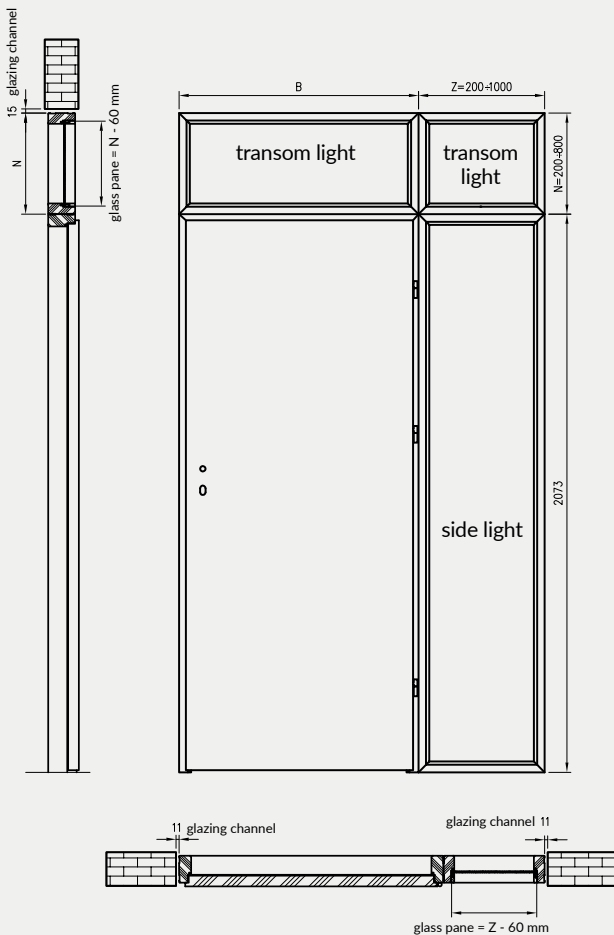
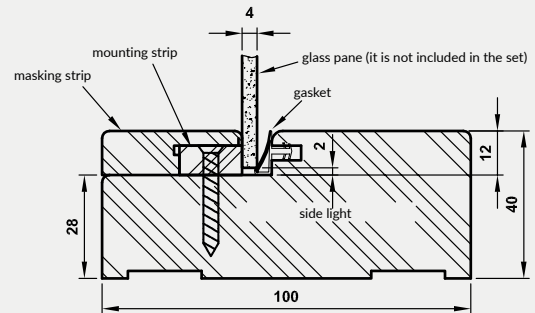

Fig. A cross-section of the transom light/sidelights



Dimensions of transom lights/sidelights

range of products	height total	width total	length of the perimeter
side light	2073 mm	Z	$2 \cdot 2073 + 2 \cdot Z$
sidelight	N	Z	$2 \cdot N + 2 \cdot Z$
transom light	N	B	$2 \cdot N + 2 \cdot B$

available options of transom lights heights

„N” = 200-800 mm.

available options of the width of transom and side lights

„Z” = 200-1000 mm.

Width of the upper "B" transom lights is adjusted to the width of the fixed door frames; the available options of the width of fixed door frames; available options of the widths can be found in the following tables:

The transom lights are mounted on the single-leaf door frame

	"60"	"70"	"80"	"90"	"100"	"110"
B	688	788	888	988	1088	1188

Transoms mounted with the door frame in double-leaf doors

	„100d"	„110d"	„120"	„130"	„140"	„150"	„160"	„170"	„180"	„190"	„200"
B	1123	1223	1323	1423	1523	1623	1723	1823	1923	2023	2123

Price of the transom lights/sidelights is calculated per one meter of circumference measured on the outer side of the transom lights/sidelights.

1 linear meter of transom lights / sidelights price is in Cell, 3D, CPL decors and painted. Dimensions shall be specified in mm.

To place an order please contact the Investment Department - phn. 55 236 42 59

NOTE: height of the sidelight is adapted to the standard height of the fixed door frame. Therefore, we do not recommend shortening door frames in configuration with the sidelight.

ENTER/SOLID

REBATED DOOR LEAF
interior entrance



STANDARD OPTIONS

- » door leaf frame made of MDF additionally reinforced with two flat metal bars
- » core made of tubular chipboard
- » external HDF board - flat or with decorative milling .
- » 3 silver screw-in pivot hinges
- » straight edge **ig. 1** or edge R 2,5 mm (in CPL laminate) **ig. 2**

REBATED DOOR LEAF MODEL ENTER:

- » bottom deadbolt lock adapted for door lock cylinder
- » upper deadbolt lock adapted for door lock cylinder
- » Door leaves are available in the investment dimension "90E" (door frame passage with opened door leaf at 90 degree = 900mm)

REBATED DOOR LEAF SOLID

- » multipoint mortise lock
- » hinges reinforced with anti-thrust bolts
- » Door leaves are available in the investment dimension "90E" (door frame passage with opened door leaf at 90 degree = 900mm)

APPLICATION

Door leaf ENTER and SOLID can be used as internal entrance door in multifamily and in public utility buildings.

CONSTRUCTION

Construction door leaf frame is made of MDF, additionally reinforced with two flat metal bars. Core is made of perforated chipboard. Door leaf unit has increased acoustic insulation (Rw=32dB). External HDF board is ennobled with DRE-Cell veneer - optional - flat finishing or decorative milling. **Door leaf models ENTER/SOLID are available with 0,7 mm CPL laminate - to place an order and for more information please contact Customer Service Department.** NOTE: Model ENTER 0 and SOLID 0 - door leaves in CPL laminate and edge with radius R 2,5 mm as standard option. It is recommended to use fixed door frame ENTER/SOLID or metal door frames together with door leaf collection ENTER/SOLID.

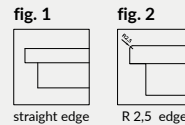

* door handle and upper backplate METRO, set of cylinder lock insert - single key system

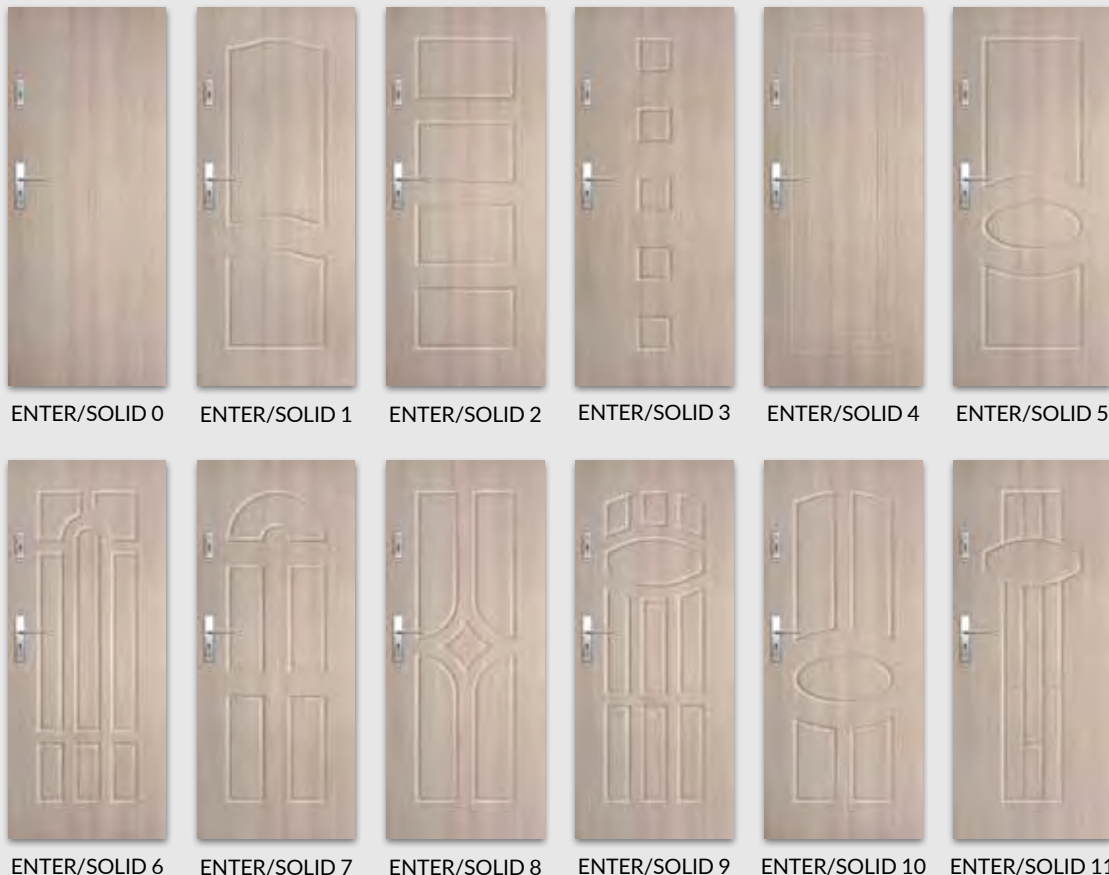



OPTIONS AVAILABLE WITH EXTRA CHARGE

- » viewfinder - included separately
- » digital viewfinder DDS1 - included separately
- » digital viewfinder DDS2 - included separately
- » stainless steel threshold - width 70 mm
- » resignation from the second lock (Enter)
- » dropping seal

											light gray matt	white matt	silver	DRE-Cell 1 decor		
white (textured)	walnut	white pine	siberian elm	sand oak	bleached oak textured	vintage oak	caramel walnut	golden oak textured	dark walnut textured	gray oak textured***	tabac elm	anthracite elm	dark wenge	Decor DRE-Cell 2		
*** decor available only in horizontal wood grain *while stock last											gray textured	black textured	toffee oak ***	marrone chestnut textured	evoked oak	
											grand oak	elm	american walnut	ebony*	Polish oak 3D	Decor 3D
white	milky white	ashen	dark gray	concrete 2	gray oak	welsh oak	acacia	celini walnut	walnut	honey oak	chestnut	roasted walnut		Laminate CPL		

ENTER/SOLID

REBATED DOOR LEAF
interior entrance



*** door handle and upper backplate, set of cylinder insert - single key system.

STANDARD OPTIONS

- » door leaf frame made of MDF additionally reinforced with two flat metal bars
- » core made of tubular chipboard
- » external HDF board - flat or with decorative milling .
- » 3 silver screw-in pivot hinges
- » straight edge fig.1 or edge R 2,5 mm (in CPL laminate) fig. 2

REBATED DOOR LEAF MODEL ENTER:

- » bottom deadbolt lock adapted for door lock cylinder
- » upper deadbolt lock adapted for door lock cylinder
- » Door leaves are available in the investment dimension "90E" (door frame passage with opened door leaf at 90 degree = 900mm)

REBATED DOOR LEAF SOLID

- » multipoint mortise lock
- » hinges reinforced with anti-thrust bolts
- » Door leaves are available in the investment dimension "90E" (door frame passage with opened door leaf at 90 degree = 900mm)

Door leaf ENTER and SOLID can be used as internal entrance door in multifamily and in public utility buildings.

It is recommended to use fixed door frame ENTER/SOLID or metal door frames together with door leaf collection ENTER/SOLID.

CONSTRUCTION

Construction door leaf frame is made of MDF, additionally reinforced with two flat metal bars. Core is made of perforated chipboard. Door leaf unit has increased acoustic insulation (Rw=32dB). External HDF board is ennobled with DRE-Cell veneer - optional - flat finishing or decorative milling.

fig. 1



straight edge

fig. 2



R 2,5 edge

APPLICATION



ENTER/SOLID 12 ENTER/SOLID 13 ENTER/SOLID 14 ENTER/SOLID 15 ENTER/SOLID 16 ENTER/SOLID 17



ENTER/SOLID 18 ENTER/SOLID 19* ENTER/SOLID 20* ENTER/SOLID 21** ENTER/SOLID 22** ENTER/SOLID 23**

* in models 19 and 20 veneer is glued in strips with variable wood grain.

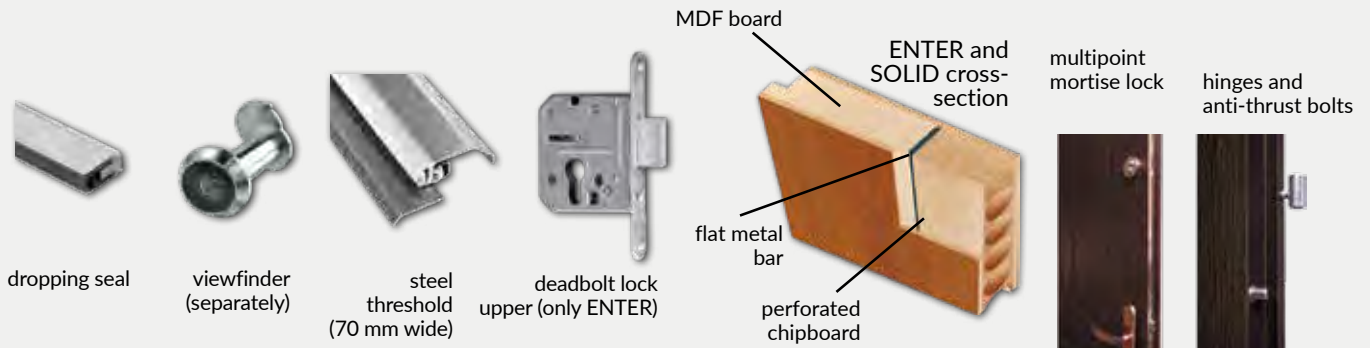

NOTE: models ENTER 21-23 and SOLID 21-23 - door leaves in CPL laminates and edge with R 2,5 mm radius as a standard.

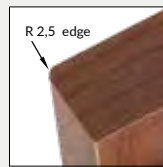
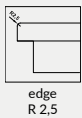

R 2,5 mm edge in CPL laminate



**in 21-23 models there are 8mm inserts located in one plane with the door leaf surface on both sides



											light gray matt	white matt	silver	DRE-Cell 1 decor	
white (textured)	walnut	white pine	siberian elm	sand oak	bleached oak textured	vintage oak	caramel walnut	golden oak textured	dark walnut textured	gray oak textured***	tabac elm	anthracite elm	dark wenge	Decor DRE-Cell 2	
											gray textured	black textured	toffee oak***	marrone chestnut textured	evoked oak
											grand oak	elm	american walnut	ebony*	Polish oak 3D
white	milky white	ashen	dark gray	concrete 2	gray oak	welsh oak	acacia	celini walnut	walnut	honey oak	chestnut	roasted walnut	Laminate CPL		

*** decor available only in horizontal wood grain

*while stock last



SOLID RC2 - gray oak CPL

STANDARD OPTION:

- » door leaf frame made of soft wood
- » core made of full chipboard
- » straight edge
- » multipoint mortise lock
- » anti-thrust bolts
- » 3 triple hinges
- » HDF external board with aluminum sheet

SOLID RC2 doors with the acoustic insulation $R_w=32dB$ and antiburglary class RC2 according to PN-EN 1627:2012, provided that the door leaf is combined with steel door frame, steel threshold and purchased separately set of fittings i.e.: door handles, long backplates and cylinder inserts. Photo of the door handle and long backplate on page 158

APPLICATION

Door leaf SOLID RC2 can be used as internal entrance door in multifamily buildings and in public utility buildings. It can be used together with door frames:

- » OSS (fixed steel door frame) informations and prices - p. 144-145
- » OSR (steel adjustable door frame), informations and prices - p. 146-147
- » OSH (hybrid steel door frame) informations and prices - p. 149-150

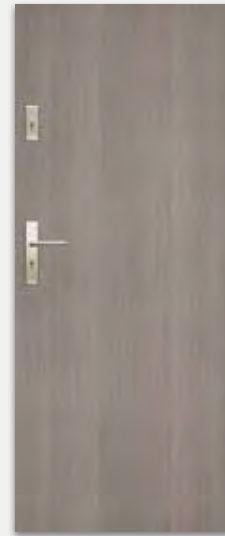

SOLID RC2



threefold hinge E878

OPTIONS AVAILABLE WITH EXTRA CHARGE

- » viewfinder - separately
- » door leaf „100”
- » steel threshold
- » ONTARIO door handle
- » ONTARIO backplate
- » cylinder lock insert (price for 2 pcs.)

OPTIONS WITHOUT EXTRA CHARGE

Door leaves are available in the investment dimension "90E"
(door frame passage with opened door leaf at 90 degree
= 900mm)

white	milky white	ashen	dark gray	concrete 2	gray oak	welsh oak	acacia	celini walnut	walnut	honey oak	chestnut	roasted walnut	Laminate CPL
white matt	light gray matt	dark gray matt	brown matt	white semigloss	light gray semi-gloss	Dark gray semi-gloss	brown semi-gloss	beige semigloss	black matt	Black semi-gloss	Available colours metal door frames		
RAL 9003	RAL 7047	RAL 7024	RAL 8017	RAL 9003	RAL 7047	RAL 7024	RAL 8017	RAL 1001	RAL 9005	RAL 9005			

Door frames colours are in two gloss scale (matt/low structure, semi gloss/plain).

FIRE RESISTANT DOOR LEAF ATHOS



REBATED

Interior entrance door

ATHOS TECHNICAL DOORS MEET THE FOLLOWING REQUIREMENTS:

- » fire resistance class: EI30 with a steel door frame
- » fire resistance class: EI30 with a wooden door frame
- » smoke proof class: Sa, S₂₀₀
- » mechanical resistance class: 3
- » sound insulation class: RW=32 dB
- » acoustic insulation class: Rw = 37 dB with a wooden door frame and wooden threshold

APPLICATION

Interior entrance fire-resistance doors, are used in residential housing, public utility buildings and collective residential buildings, as well as commercial and technical premises.

STANDARD OPTION

- » door leaf frame made of soft wood
- » core made of full chipboard
- » straight edge
- » single-point mortise lock adapted for cylinder lock
- » 3 triple hinges

DOOR FRAMES

- » fixed metal door frame p. 144
- » adjustable metal door frame p.146
- » steel hybrid door frame p.149
- » wooden door frame p. 121

OPTIONS AVAILABLE WITH EXTRA CHARGE

- » selfcloser DORMA TS-71
- » selfcloser DORMA TS-90
- » selfcloser GEZE TS 2000
- » door leaf "100" - "110"
- » viewfinder
- » wooden threshold

In order to comply with the conditions of the National Technical Assessment, doors with fire resistance EI 30 should be equipped with a selfcloser.

CAUTION: The price of the door leaf should be increased by the price of the steel or wooden door frame.



ATHOS 10

Laminate
CPL

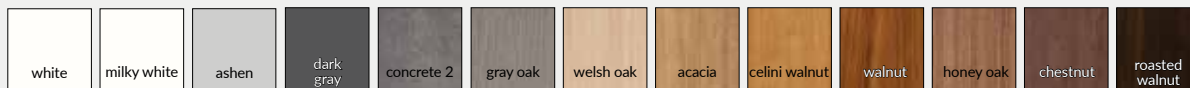

CONSTRUCTION

Wooden door frame for ATHOS is made of glued pine wood, covered with CPL O, 15-0,2 mm laminate on the exposition side. Frame beams, with a fixed width of 100mm, are cut at an angle of 90°. An intumescent gasket with fire-resistant properties is glued in the channel, milled in the notch of the beams.

APPLICATION

ATHOS wooden door frames are dedicated to Athos door leaves, which as a set, installed in accordance with the National Technical Assessment No. 2018/0633, they constitute a partition with fire resistance EI 30. Moreover, equipped with a fixed threshold, they meet the acoustic insulation criteria in accordance with the class $R_w = 37$ dB, and in the configuration with a dropping seal, without a fixed threshold, $R_w = 32$ dB.

SET CONTAINS

- » Main beams (lintel, latch plate beam with the main lock catch and main beam with the hinges with milled holes for the yokes and three-part hinges and mounted anti-theft bolt sockets), rebate gasket, three hinges (middle part of the three-part hinge) + 3 hinge yokes, a set of elements to be assembled door frame according to the attached instructions.

The door frames are packed in cardboard boxes.

Assortment of wooden frames:

- » OD ATHOS - for Athos door with a fixed threshold
- » OD ATHOS UO - for Athos doors with a dropping seal

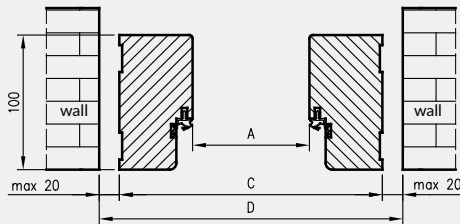

Wooden door frame dimensions for Athos doors

width.	A	C	D
"80"	802	910	934
"90"	902	1010	1034
"90E"	917	1025	1049
"100"	1002	1110	1134
"110"	1102	1210	1234

D - width of the assembly hole

Wooden door frame for Athos door with a fixed threshold

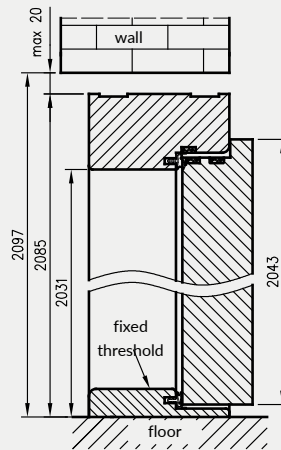

Wooden door frame for Athos door with dropping seal *

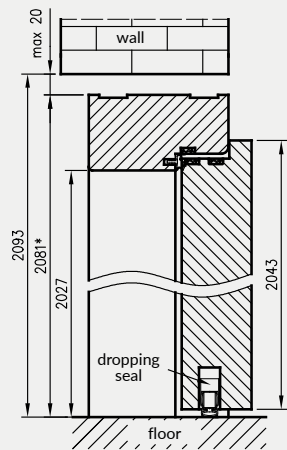

Laminate
CPL



FORCA TECHNICAL DOORS MEET THE FOLLOWING REQUIREMENTS:

- » class of anti-burglary:
RC3 (according to PN-EN 1627: 2012)
- » fire resistance class: EI₃₀
- » smoke proof class: Sa, S₂₀₀
- » mechanical resistance class: 3
- » acoustic insulation class: Rw = 37 dB with a steel frame and a metal threshold

APPLICATION

Interior entrance, fire resistance and anti-burglary doors are used in residential housing, public utility buildings and collective residential buildings as well as commercial and technical premises. Doors are sold only as a complete set with metal door frame, metal threshold, door handle, backplate and two cylinder inserts.

STANDARD OPTION

- » door leaf frame made of soft wood
- » core made of full chipboard
- » straight edge
- » steel strings
- » 5-point mortise lock
- » 3 triple hinges

DOOR FRAMES

- » fixed metal door frame p. 144
- » adjustable metal door frame p.146
- » steel hybrid door frame p.149

OPTIONS AVAILABLE WITH EXTRA CHARGE

- » steel threshold
- » handle-handle F1 color*
- » long backplate F1 color*
- » cylinder lock insert x 2 pcs.
- » selfcloser DORMA TS-71
- » selfcloser DORMA TS-90
- » selfcloser GEZE TS 2000
- » door leaf "100"
- » viewfinder

In order to comply with the conditions of the National Technical Assessment for doors with EI 30 fire resistance and anti-burglary properties, doors should be equipped with a self closer and DIVA door handle with long backplate. Picture of door handle and backplate - p. 158.

NOTE: The price of the door leaf should be increased by the price of steel door frame, steel threshold, door handle, backplate and two pcs. of cylinder lock inserts.

* - F8 black anode color, available for contract orders, after consultation and individual price verification with the Investment Department.

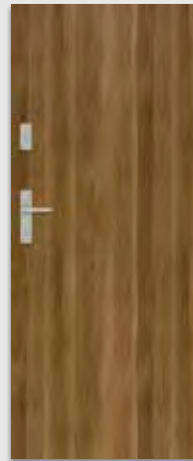

FORCA 10

CPL Lami-
nate

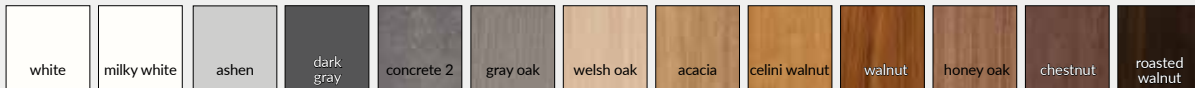



FORCA B TECHNICAL DOORS MEET THE FOLLOWING REQUIREMENTS:

- » class of anti-burglary:
RC3 (according to PN-EN 1627: 2012)
- » mechanical resistance class: 3
- » acoustic insulation class: $R_w = 37$ dB with a steel frame and a metal threshold

APPLICATION

Interior entrance, fire resistance and anti-burglary doors are used in residential housing, public utility buildings and collective residential buildings as well as commercial and technical premises. Doors are sold only as a complete set with metal door frame, metal threshold, door handle, backplate and two cylinder inserts.

STANDARD OPTION

- » door leaf frame made of soft wood
- » core made of full chipboard
- » straight edge
- » steel strings
- » 5-point mortise lock
- » 3 triple hinges

DOOR FRAMES

- » fixed metal door frame p. 144
- » adjustable metal door frame p.146
- » steel hybrid door frame p.149

OPTIONS AVAILABLE WITH EXTRA CHARGE

- » steel threshold
- » handle-handle F1 color*
- » long backplate F1 color*
- » cylinder lock insert x 2 pcs.
- » door leaf "100"
- » viewfinder

NOTE: The price of the door leaf should be increased by the price of steel door frame, steel threshold, door handle, backplate and two pcs. of cylinder lock inserts.

* - F8 black anode color, available for contract orders, after consultation and individual price verification with the Investment Department.



FORCA B 10



CPL Lami-
nate



OLIMP 10 - white matt

CPL Lami-
nate



STANDARD OPTIONS

- » core made of Halspan chipboard 44 mm in EI30 or 54 mm in EI 60 with additional pine wood strips attached circumferentially
- » straight edge, rounded glass pane frame **fig.1**
- » transparent fire - resistance glass pane (variable width dependent upon the size of the door leaf)
- » intumescent smoke-proof gasket
- » 3 hinges
- » cylinder insert lock
- » dropping seal

fig. 1



straight edge with rebate



rounded glass pane frame
22x28 mm



fire-resistant ventilation grille.



GEZE TS 2000 self closer



DORMA self closer
TS-71



DORMA TS-90 impuls self closer



Acoustic sound insulation class for single leaf door $R_w=32$ dB
Acoustic sound insulation rate for double leaf door $R_w=27$ dB

NOTE: In door leaf with fire-resistance EI30 there are used three triple hinges, while in door leaf with fire resistance EI60 there are used VX7939 hinges.

OPTIONS AVAILABLE WITH EXTRA CHARGE

- » viewfinder
- » selfcloser DORMA TS-71
- » selfcloser DORMA TS-90
- » selfcloser GEZE TS 2000
- » fire resistance ventilation grille.
- » extra charge for passive door leaf

APPLICATION

Fire-resistance doors are used as interior entrance doors in residential housing, public utility buildings and collective residential buildings. In order to comply with the conditions of the National Technical Assessment self closer should be applied in doors with fire-resistance EI30 and EI60. Doors are sold only as a set with a metal fire-resistance door frame.



OLIMP 10



OLIMP 20



OLIMP 30



OLIMP 40

METAL FIRE RESISTANT DOOR FRAME

CONSTRUCTION

Metal door frame is made of carbon steel construction plate with a minimum thickness 1,5 mm, structure is welded and powder-coated in brown or white colour.

APPLICATION

Door frame is applied to the interior entrance fire-resistance doors OLIMP EI60.

STANDARD OPTIONS

- » 3 hinges
- » gasket with enhanced flame-resistance properties

OLIMP EI-60 door leaf vertical cross-section

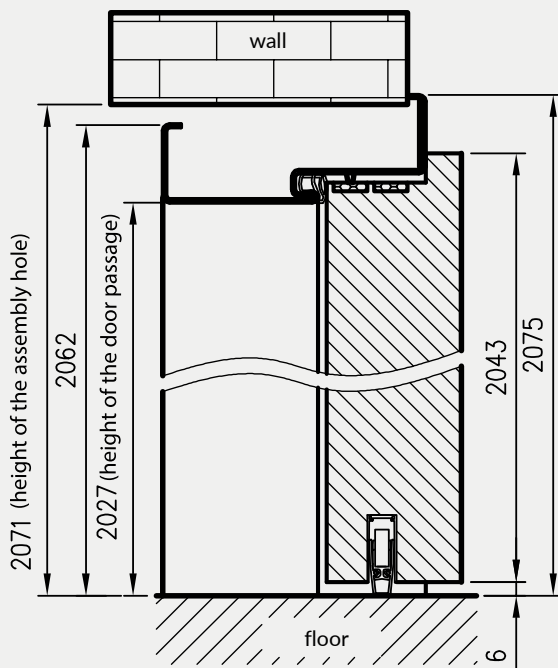

horizontal cross-section of door frame mounted in the wall

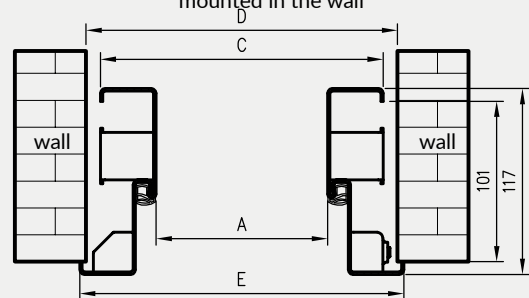

D - width of the assembly hole

door frame profile

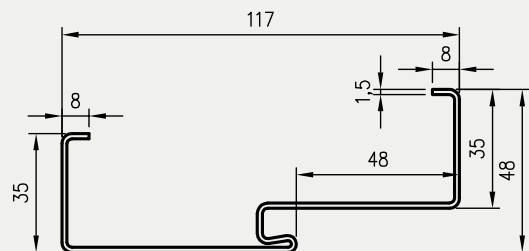

OSPP EI60 dimensions for single leaf door

	A	C	D	E
"80"	801	871	889	897
"90"	901	971	989	997
"90E"	926	996	1014	1022
"100"	1001	1071	1089	1097
"110"	1101	1171	1189	1197

Dimensions of OSPP EI60 for double leaf doors

	A	C	D	E
"160"	1636	1706	1724	1732
"170"	1736	1806	1824	1832
"180" = "90" + "90"	1836	1906	1924	1932
"200" = "100" "100"	2036	2106	2124	2132
"210"	2136	2206	2224	2232
"220"	2236	2306	2324	2332



threefold hinge

Hinge SIMONSWERK VX 7939/160 (for door widths "100" and "110")

WOODEN FIRE RESISTANT DOOR FRAME.

for Olimp EI-30 door leaf

CONSTRUCTION

Fixed wooden door frame with cross-section 54X100 mm is made of coniferous wood coated in door leaf unit colour with 0,2 CPL laminate.

APPLICATION

Door frame is applied to the interior entrance fire-resistance doors OLIMP EI30.

STANDARD OPTION

EI30 door frame

- » 3 hinges
- » gasket with enhanced flame-resistance properties
- » latch strike plate
- » mounting kit

Cross-section of fire resistance wooden door frame for OLIMP

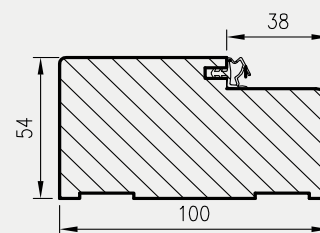

vertical cross-section of fire-resistance door leaf.

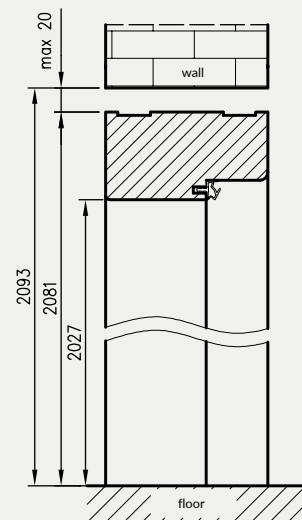

horizontal cross-section door frame in the wall

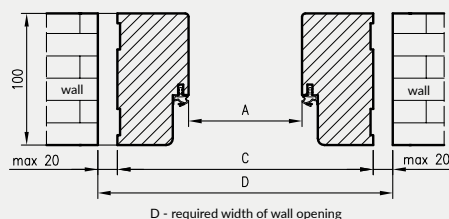

for single-leaf doors

	A	C	D
80	802	910	934
90	902	1010	1034
90E	917	1025	1049
100	1002	1110	1134
110	1102	1210	1234

for double-leaf doors

	A	C	D
160	1637	1745	1769
170	1737	1845	1869
180	1837	1945	1969
190	1937	2045	2069
200	2037	2145	2169

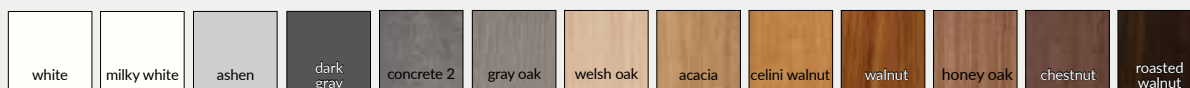

Laminate
CPL

ENTER ACOUSTIC TECHNICAL DOORS MEET THE FOLLOWING REQUIREMENTS:

- » mechanical resistance class: 3
- » sound insulation class $R_w = 32\text{dB}$

APPLICATION

Door leaf ENTER ACOUSTIC are designed to be used as interior entrance door in multifamily buildings and in public utility buildings

STANDARD OPTION:

- » door leaf frame made of MDF additionally reinforced with two flat metal bars
- » core made of tubular chipboard
- » flat external HDF board
- » dropping seal
- » 3 silver screw-in pivot hinges
- » straight edge or edge R 2,5 mm (in CPL laminate)
- » bottom deadbolt lock adapted for cylinder lock insert
- » Door leaves are available in the investment dimension "90E" (door frame passage with opened door leaf at 90 degree = 900mm)

DOOR FRAMES:

- » steel hybrid door frame p.149
- » adjustable metal door frame p.146
- » fixed metal door frame p. 144
- » fixed rebated door frame p. 132
- » adjustable door frame with T80 architrave, T63 p. 134

OPTIONS AVAILABLE WITH EXTRA CHARGE:

- » viewfinder - included separately
- » door leaves "110"

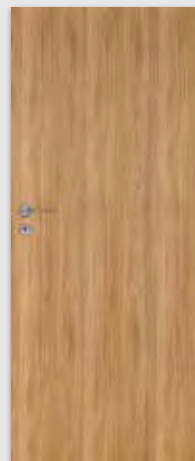

ENTER 0 ACOUSTIC

Decor DRE-Cell 1	silver	white matt	light gray matt											
Decor DRE-Cell 2	dark wenge	anthracite elm	tabac elm	gray oak textured**	dark walnut textured	golden oak textured	caramel walnut	vintage oak	bleached oak textured	sand oak	siberian elm	white pine		
	evoked oak	marrone chestnut textured	toffee oak ***	black textured	gray textured	walnut	white (textured)							
Decor 3D	Polish oak 3D	ebony*	american walnut	elm	grand oak									
Laminate CPL	roasted walnut	chestnut	honey oak	walnut	celini walnut	acacia	welsh oak	gray oak	concrete 2	dark gray	ashen	milky white	white	

* decor available while stocks last *** decor only in horizontal grain



GALLA 1
transparent



GALLA 1
decormat



GALLA 1
decormat brown



GALLA 1
decormat graphite



GALLA 2
sand blasted glass
transparent strips



GALLA 3
sand blasted glass
transparent strips



GALLA 10
decormat
screen printing



GALLA 10
transparent glass
screen printing



GALLA 11
decormat
screen printing



GALLA 11
transparent glass
screen printing



GALLA 12
decormat
screen printing



GALLA 13
decormat
screen printing

Door leaf is made of tempered, 8mm glass pane.

OPTIONS AVAILABLE WITH EXTRA CHARGE

- » ventilation undercut available in swing door leaf
(in "80" and "90" meets ventilation requirements)

FITTINGS FOR GLASS DOORS

DOOR LEAF

SELECTION OF LOCKS FOR GLASS DOORS

Depending on door leaf opening direction (left/right):

GEZE toilet locks are configured, for left door leaf - left locks are used for right door leaf - right door locks are used remaining door locks are universal use (they can be configured left or right).

In toilet lock it is necessary to choose one of the following combinations which present assembly situation (difference is in door leaf opening direction and/or placement of toilet blockade):

fig. 1 right door leaf /blockade outside

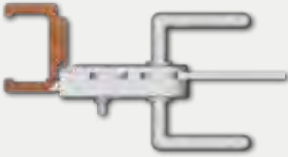

fig. 2 left door leaf/blockade outside

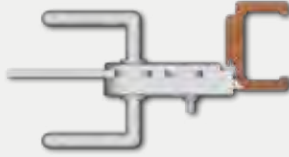

fig. 3 right door leaf/blockade inside

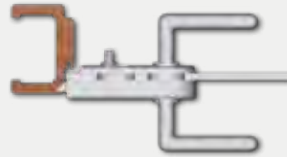
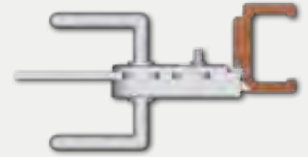

fig. 4 left door leaf/blockade inside



Geze toilet locks - select right toilet lock outside.
remaining locks - select left lock*

Geze toilet locks - select left toilet lock outside.
remaining locks - select left lock*

Geze toilet locks - select right toilet lock inside.
remaining locks - select right lock*

Geze toilet locks - select left toilet lock inside.
remaining locks - select right lock*

* In toilet locks, except Geze and metalbud locks, definition "left", "right" refers to placement of toilet blockade: description "left lock" means that blockade is placed on exterior side of the door leaf, description "right lock" means that blockade is placed on interior side of the door leaf.

HARDWARE



** It is necessary to purchase cylinder insert 21/26 separately (see details in the table above)

*** Toilet lock - selection of toilet lock see details above

DOOR LEAF DIMENSIONS AND PLACEMENT OF HARDWARE

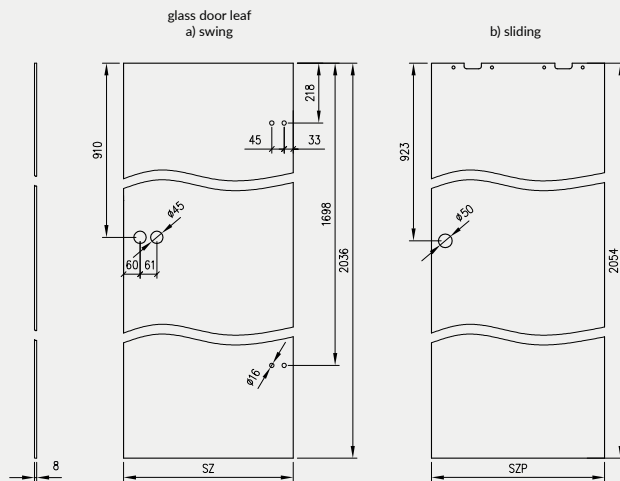

Door leaf unit is made of safe, plain or glued, tempered 8mm glass pane which has in standard option holes for assembly of:

- » hinges and lock in swing doors leaf
- » round door handle and hardware adapted for sliding system door leaf

APPLICATION

Glass door leaf are used as interior doors in residential housing, public utility buildings and collective residential buildings.

OPENING DIRECTION OF GLASS DOOR LEAF

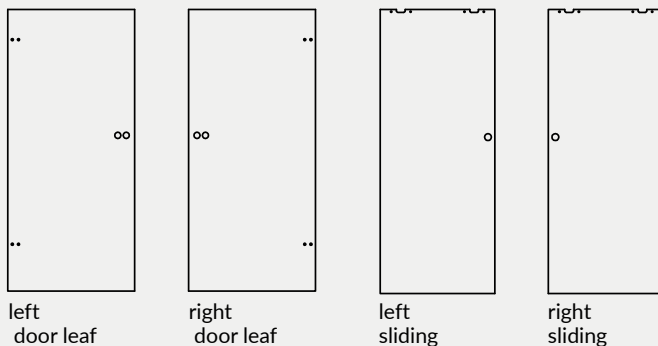

There are two different sides of glass pane in Galla door leaves (does not refer to transparent Galla1).

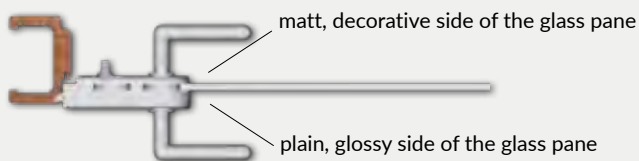

DOOR LEAF WIDTH

Symbol of the door dimension	SZ	SZP
"60"	617	630
"70"	717	730
"80"	817	830
"90"	917	930

SZ - width of glass swing door leaf

SZP - width of glass sliding door leaf

DOOR LEAF HEIGHT

2036 mm - height of glass swing door leaf

2054 mm - height of glass sliding door leaf

NOTE: There is no possibility to shorten glass door leaf.

CLEARANCE BETWEEN DOOR LEAF AND FLOOR

Standard clearance between door leaf unit and ready floor is 8 mm.

NOTES REFERED TO HINGE

DOOR FRAMES applied to glass doors should be equipped with two pivot \varnothing 15 mm.

FULFILMENT OF VENTILATION REQUIREMENTS FOR GLASS DOORS

symbol dim. DOORS	doors with ventilation undercut	
	ventilation surface of the undercut and the clearance 8 mm [m ²]	required clearance to meet ventilation requirements [in mm]
"90"	0,027	2
"80"	0,024	5,5
"70"	0,021	10*
"60"	0,017	16*

* - door leaf „60" and „70" doesn't meet ventilation requirements.

Ventilation undercut (only active door leaf)

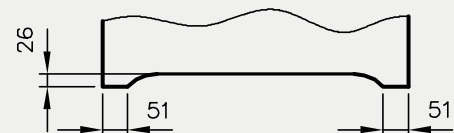

In order to meet ventilation requirement - total ventilation surface 0,022 m², there must be used ventilation undercut in active glass door leaf with "80" - "90" width and standard clearance between door leaf and floor (8mm).

FIXED DOOR FRAMES

REBATED - OP

CONSTRUCTION

Fixed door frame is made of high-quality wood-based board and it is coated with ecological, wood-like decorative DRE-Cell veneer, 3D veneer, 0,15 - 0,20 mm CPL, finish veneer or painted.

Door frames has fixed width of 100 mm.

APPLICATION

Fixed door frame can be used in the following types of doors:

- » ENTER entrance doors (equipped with 3 ø 13,5 mm hinges and additional upper latch plate)
- » SOLID entrance doors (equipped with 3 ø 13,5 mm hinges and 4 hooks for the latch and latches of the flat multi-point lock)
- » glass doors ("OPC" they are equipped with two hinges ø 15 mm, special latch plate and rubber seal strip)
- » other remaining rebated door leaf (using 2 or 3 ø 13,5 mm hinges, in all frame construction door and panel door collections having size "90" and wider; door frames should be equipped with 3 hinges)

Masking architraves are used in fixed door frames and SOFT door frames, whereas for the fixed SOFT natura door frames angular architrave are used.

THE SET CONTAINS

Main beam (one horizontal and two vertical elements), door seal, a set of hinges, all necessary components for the installation of door frames in accordance with the supplied instruction. Door frames are packed in cardboard boxes.

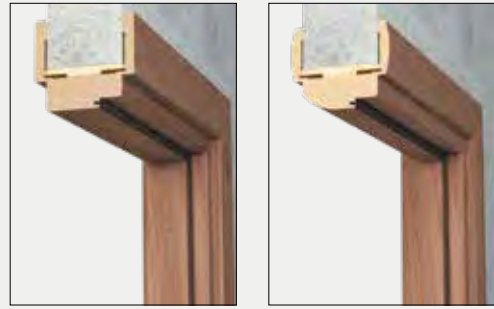

OP profile

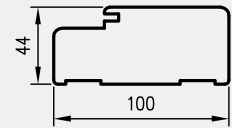

OP SOFT profile

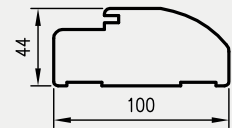

OP vertical cross-section for rebated door leaf

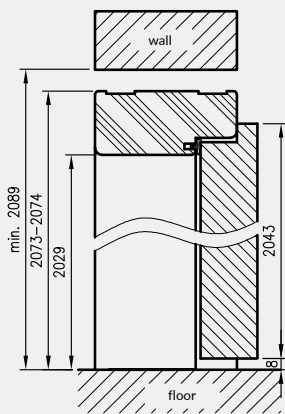

required height of wall passage 2089 mm (2095 mm for glass doors)

OP vertical cross-section for glass doors

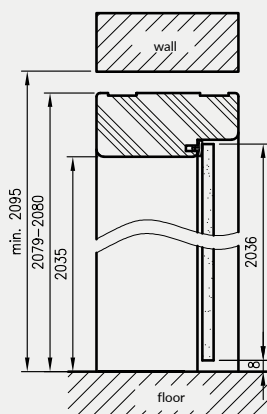

OP Horizontal cross section

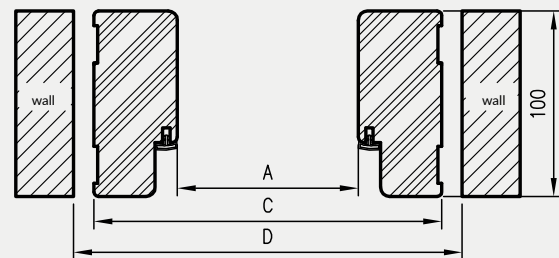

for single-leaf doors

	A	C	D
"60"	600	688	712
"70"	700	788	812
"80"	800	888	912
"90"	900	988	1012
"90E"	904	992	1016
"100"	1000	1088	1112
"110"	1100	1188	1212

for rebated door leaf double-leaf doors

	A	C	D
„100d"	1035	1123	1147
„110d"	1135	1223	1247
„120"	1235	1323	1347
„130"	1335	1423	1447
„140"	1435	1523	1547
„150"	1535	1623	1647
„160"	1635	1723	1747
„170"	1735	1823	1847
„180"	1835	1923	1947
„190"	1935	2023	2047
„200"	2035	2123	2147

* door frames for glass doors, width "60" - "90"
D - required width of wall opening

OPTIONS AVAILABLE WITH EXTRA CHARGE

- » door frame ENTER (with latch deadbolt plate)
- » door frame for SOLID
- » door frame for double leaf door:

+30%

FIXED DOOR FRAMES

NON-REBATED - OPB

CONSTRUCTION

Fixed non-rebated door frame is made of high-quality wood-based board and it is coated with ecological, wood-like decorative DRE-Cell veneer, 3D veneer, 0,15 - 0,20 mm CPL or painted. Door frames has fixed width of 100 mm.

APPLICATION

Fixed non-rebated door frame can be applied to all DRE collections which are available in non-rebated option.

SET CONTAINS

Main beam (one horizontal and two vertical elements), door seal, a set of hinges, all necessary components for the installation of door frames in accordance with the supplied instruction. Door frames are packed in cardboard boxes.



OPB vertical cross-section

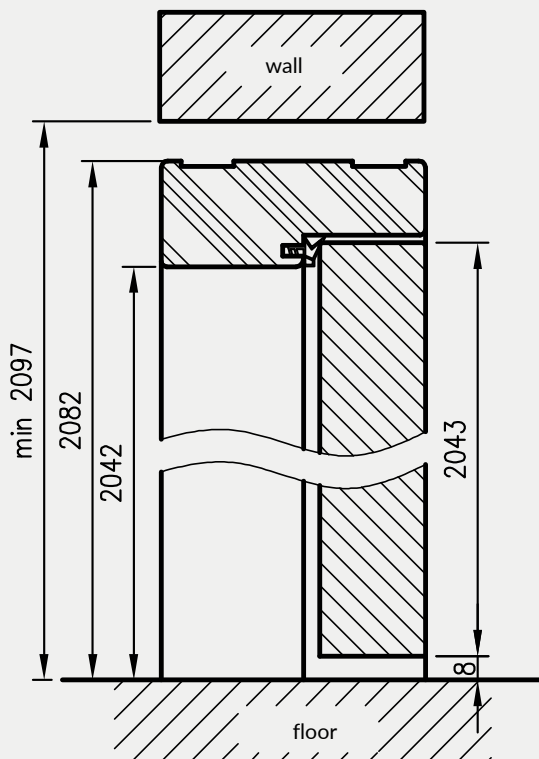

required height of the wall opening 2097 mm

D - required width of wall opening

OPB Horizontal cross section

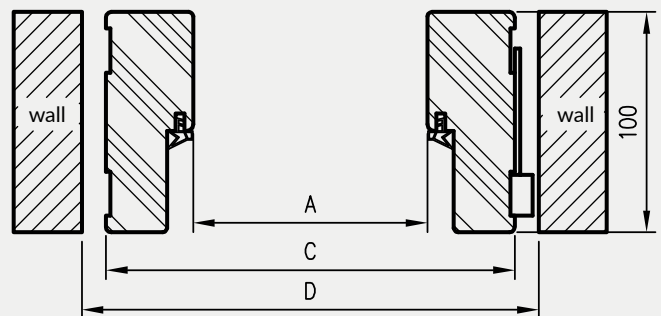

OPB profile

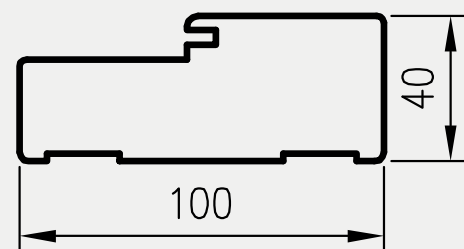

for single-leaf doors

	A	C	D
"60"	627	707	730
"70"	727	807	830
"80"	827	907	930
"90"	927	1007	1030
"100"	1027	1107	1130

for double-leaf doors

	A	C	D
„120"	1274	1354	1380
„130"	1374	1454	1480
„140"	1474	1554	1580
„150"	1574	1654	1680
„160"	1674	1754	1780
„170"	1774	1854	1880
„180"	1874	1954	1980

Prices include 2 hinges with assembly plates.

Price of the double-leaf door frame: + 50% (if 3 hinges are used, there is additional payment)

» Extra charge for the third Estetic 80 hinge

ADJUSTABLE DOOR FRAMES

WITH ANGULAR ARCHITRAVE T80 OR T63 - OR/ORC

CONSTRUCTION

Adjustable door frame with architrave T80 or T63 is equipped with architrave elements with small radii of the transverse profile rounding. It is made of a high-quality, wood-based board. On its visual side it is entirely coated with a decorative, wood-imitation DRE-Cell foil, 3D foil, 0,15 - 0,2 mm CPL laminate or painted**. Can be used with wall thickness of 60 - 320mm.

**NOTE: To ensure the highest quality of painted door frames, before painting process they are coated with special material which constitutes solid base.

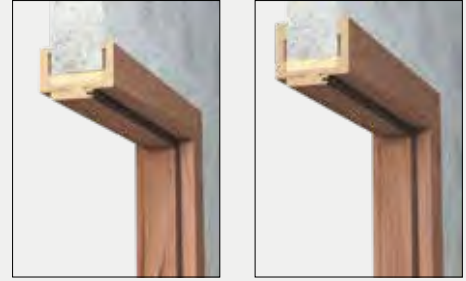

APPLICATION

Adjustable door frame can be applied for:

- » interior door leaves - rebated and for glass door leaves (ORC)
- » entrance doors ENTER (includes 3 hinges \varnothing 13, 5 mm, additional latch plate - extra charge)

SET CONTAINS

Main beam (one horizontal and two vertical elements together with masking elements), door seal, set of hinges, all necessary components for the installation of door frames in accordance with the supplied instruction. Door frames are packed in cardboard boxes.

Door frames are packed in cardboard boxes.

Door frames used as a set with frame construction doors and door frames with size "90" and wider, should be equipped with three hinges. Door frames for glass door "ORC" are equipped with two hinges \varnothing 15 mm, special latch plate and rubber seal strip.

for double-leaf doors

	A	C	D	E**	E*
100d	1035	1079	1115	1219	1185
110d	1135	1179	1215	1319	1285
120	1235	1279	1315	1419	1385
130	1335	1379	1415	1519	1485
140	1435	1479	1515	1619	1585
150	1535	1579	1615	1719	1685
160	1635	1679	1715	1819	1785
170	1735	1779	1815	1919	1885
180	1835	1879	1915	2019	1985
190	1935	1979	2015	2119	2085
200	2035	2079	2115	2219	2185

for single-leaf doors

	A	C	D	E**	E*
60	602	646	680	786	752
70	702	746	780	886	852
80	802	846	880	986	952
90	902	946	980	1086	1052
100	1002	1046	1080	1186	1152
110	1102	1146	1180	1286	1252

* dimension refer to door frame with T63 architrave

** dimension refer to door frame with T80 architrave

OR/ORC cross-section with T63 architrave

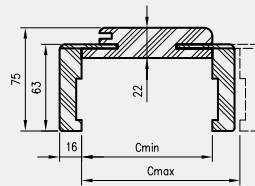

OR/ORC cross-section with T80 architrave

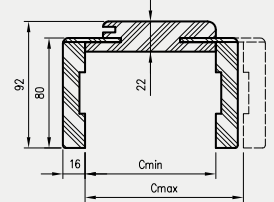

OR/ORC horizontal cross-section

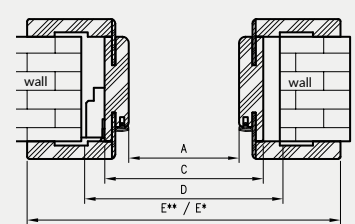

D - required width of wall opening

vertical cross-section of rebated door leaf with OR

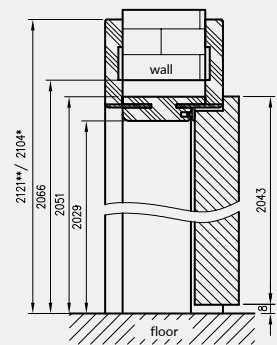

vertical cross-section of glass doors with ORC

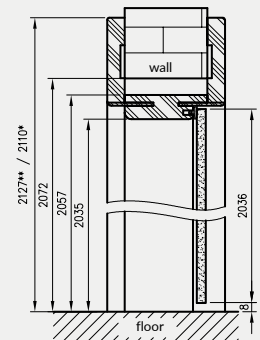

required wall passage height 2066 mm (2072 mm for glass doors)

ADJUSTABLE DOOR FRAMES

WITH VARIABLE HEIGHTS AND ANGULAR ARCHITRAVE T80 - OR

By the fact of the interest expressed by our clients in doors of custom sizes, we have introduced to our offer collections of MODERN, PLUS and STANDARD 10 door leaf model with adjustable door frame equipped with angular architrave T80 in 3 additional heights.

APPLICATION

Adjustable door frame with variable heights with T80 architrave can be used for rebated door leaf STANDARD 10, MODERN and PLUS collections with three additional leaf height options: 1983mm, 2110mm and 2240mm.

SET CONTAINS

Main beam (one horizontal and two vertical elements together with masking elements), door seal, set of hinges, all necessary components for the installation of door frames in accordance with the supplied instruction. Door frames are packed in cardboard boxes. Door frames are packed in cardboard boxes.

All rebated door frames in 3 additional height options should be equipped with 3 hinges.



OR cross-section with T80 architrave

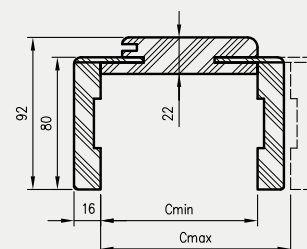

OR horizontal cross-section

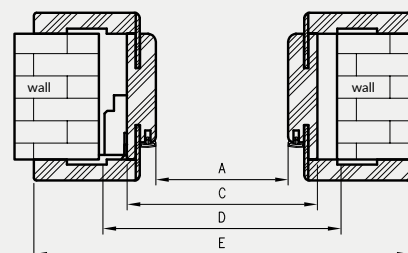

D - required width of wall opening
H - door leaf height
H0 - required the wall passage height

OR vertical cross-section

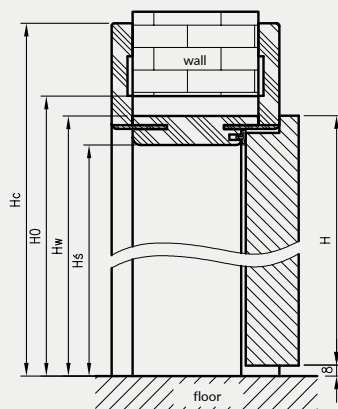
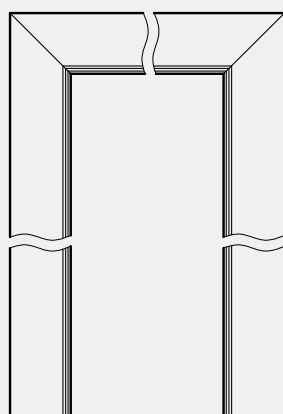

H	HS	hw	H0	HC
1983	1969	1991	2006	2061
2110	2096	2118	2133	2188
2240	2226	2248	2263	2318

for single-leaf doors

	A	C	D	E
60	602	646	680	786
70	702	746	780	886
80	802	846	880	986
90	902	946	980	1086
100	1002	1046	1080	1186

for double-leaf doors

	A	C	D	E
120	1235	1279	1315	1419
130	1335	1379	1415	1519
140	1435	1479	1515	1619
150	1535	1579	1615	1719
160	1635	1679	1715	1819
170	1735	1779	1815	1919
180	1835	1879	1915	2019
190	1935	1979	2015	2119
200	2035	2079	2115	2219

NON-REBATED ADJUSTABLE DOOR FRAMES

NON-REBATED - ORB

CONSTRUCTION

Adjustable non-rebated door frame is made of a high-quality wood-based MDF board. On its visual side it is entirely coated with a decorative wood-imitation DRE-Cell veneer, 3D veneer, CPL laminate, or painted**. Its construction allows to be used with door leaf with the thickness of 40 mm and its design allows to be used on walls with span 75-320 In white matt, black matt 2, white UV varnish, white pine, sand oak, Polish oak 3D white varnish, black varnish, decors from LUX and WOOD collections, there is possibility to choose connection of main beams at 90 degree.

**NOTE: To ensure the highest quality of painted and lacquered door frames, before varnishing or painting process they are coated with special material which constitutes solid base.

APPLICATION

Adjustable non-rebated door frame with Estetic 80 hinges applies to all DRE collections in the non-rebated hinged version with Estetic 80 hinges. Adjustable non-rebated door frame with plate hinges applies to the Sigma collection in black matt 2, lam_white and bleached craft oak laminates.

SET CONTAINS

Main beam (one horizontal and two vertical elements) with wide angular architrave (80 mm) with small rounding angles of the cross-section profile (R2), door seal, a set of hinges, all necessary components for the installation of door frames in accordance with the supplied instruction. Door frames are packed in cardboard boxes.



ORB connection at 45

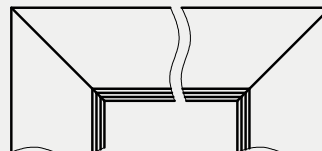

ORB connection at 90

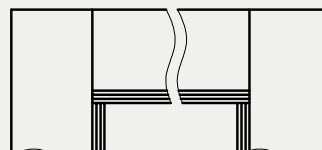

** connection at 90° is available in white matt, black matt 2, white acrylic UV varnish, white pine, sand oak, Polish oak 3D, white varnish, black varnish and LUX and WOOD collections

ORB horizontal cross-section

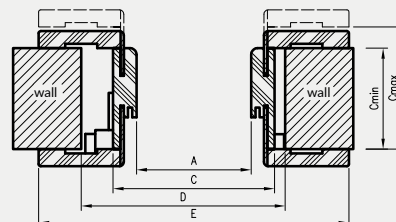

D - required width of wall opening

ORB cross-section 095-300

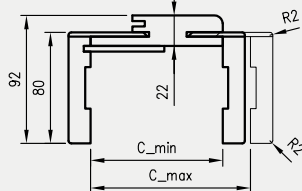

ORB cross-section 075

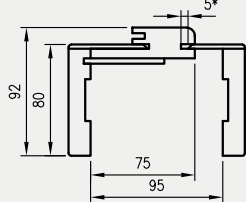

vertical cross-section of non-rebated door leaf

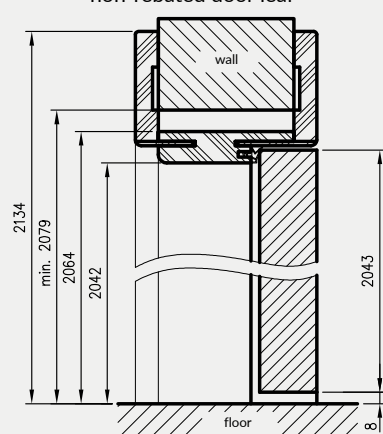

required wall passage height 2079 mm

for double-leaf doors

	A	C	D	E
120	1274	1318	1378	1458
130	1374	1418	1478	1558
140	1474	1518	1578	1658
150	1574	1618	1678	1758
160	1674	1718	1778	1858
170	1774	1818	1878	1958
180	1874	1918	1978	2058

for single-leaf doors

	A	C	D	E
60	627	671	711	811
70	727	771	811	911
80	827	871	911	1011
90	927	971	1011	1111
100	1027	1071	1111	1211

Prices include 2 hinges with assembly plates.

- » The price of the double leaf door door frame: +50% (extra charge for the third Estetic 80 hinge 2)
- » Extra charge for the third Estetic 80 hinge
- » Double leaf door frame price: +50% (extra charge for third plate hinge
- » Extra charge for the third plate hinge
- » Extra charge for connection of main beams at 90 degree available in white matt, black matt 2, white UV varnish, white pine, sand oak, Polish oak 3D, white varnish, black varnish and LUX and WOOD collections decors

NON-REBATED ADJUSTABLE DOOR FRAMES

NON-REBATED WITH VARIABLE HEIGHTS - ORB

By the fact of interest expressed by our clients in non-rebated doors of custom sizes, we have introduced to our offer collections MODERN, PLUS and STANDARD 10 door leaf model with non-rebated adjustable door frame in 3 additional heights. Construction of the door frame is the same as in the non-rebated adjustable door frame (they vary only in height).

APPLICATION

Non-rebated adjustable door frame with variable heights can be used with non-rebated STANDARD 10, MODERN and PLUS door leaf model which are available in three additional door leaf height options: 1983 mm, 2110 mm and 2240 mm.

SET CONTAINS

Main beam (one horizontal and two vertical elements together with masking architraves), door seal, set of hinges, all necessary components for the installation of door frames in accordance with the supplied instruction. Door frames are packed in cardboard boxes.

Door frames are packed in cardboard boxes.

All door frames in 3 additional height options can be equipped with 2 or 3 hinges.



ORB cross-section 095-300

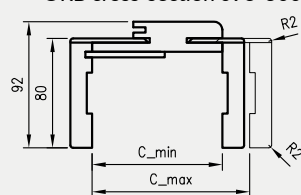

ORB cross-section 075

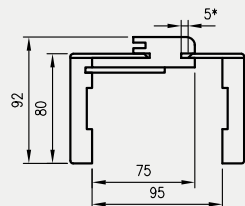

ORB vertical cross-section

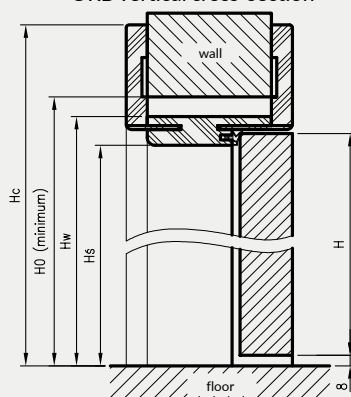

H	H _S	hw	H ₀	H _C
1983	1982	2004	2019	2074
2110	2109	2131	2146	2201
2240	2239	2261	2276	2331

H₀ - required the wall passage height

ORB horizontal cross-section

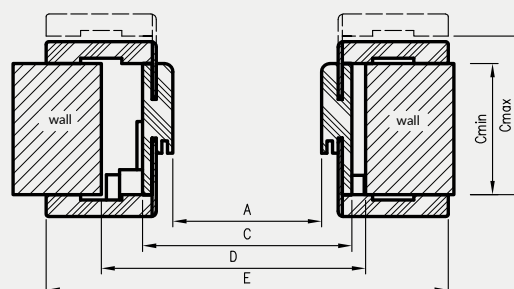

*NOTE: 075-095 door frame has a different cross-section, for a 75-89 mm wall thickness, it will be necessary to shorten tongue of the masking architrave.

for single-leaf doors

	A	C	D	E
60	627	671	711	811
70	727	771	811	911
80	827	871	911	1011
90	927	971	1011	1111
100	1027	1071	1111	1211

for double-leaf doors

	A	C	D	E
120	1274	1318	1378	1458
130	1374	1418	1478	1558
140	1474	1518	1578	1658
150	1574	1618	1678	1758
160	1674	1718	1778	1858
170	1774	1818	1878	1958
180	1874	1918	1978	2058

D - required width of wall opening

Prices include 2 hinges with assembly plates.

Price of the double-leaf door frame: + 50% (if 3 hinges are used, there is additional payment)

» Extra charge for the third Estetic 80 hinge

NON-REBATED ADJUSTABLE DOOR FRAMES

FOR DOOR LEAVES WITH INVERTED REBATE - ORO

CONSTRUCTION

Adjustable door frame with inverted rebate is made of a high-quality wood-based MDF board. On its visual side it is painted with highest quality acrylic UV varnish. To ensure the highest quality of painted door frames, before painting process they are coated with special material which constitutes solid base. Its construction allows to be used with door leaf with the thickness of 40 mm and its design allows for use on walls ranging between 90-290 mm.

APPLICATION

Door frame can be applied to door leaves with inverted rebate, from collection: Uni, Binito, Fargo.

THE SET CONTAINS

Main beam (horizontal and two vertical elements), architrave T80 (horizontal and two vertical elements), door seal, set of two Estetic 1821 hinges, magnetic lock latch, door frame assembling set with the manual. Door frames are packed in cardboard packaging.



door frame profile

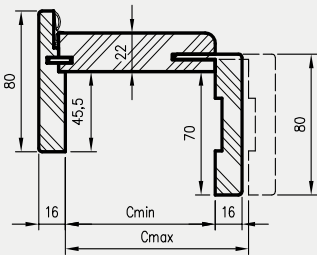

vertical cross-section of ORO

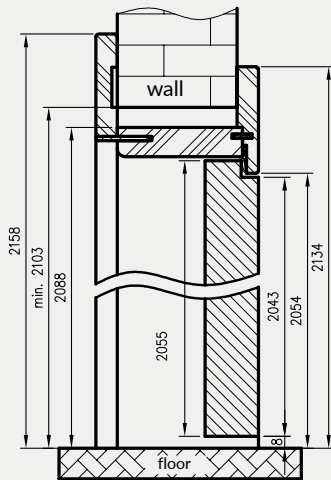

Required height of the wall opening = 2103 mm

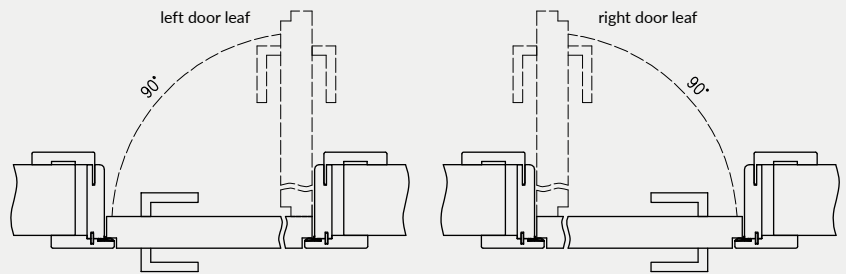

horizontal cross-section of ORO

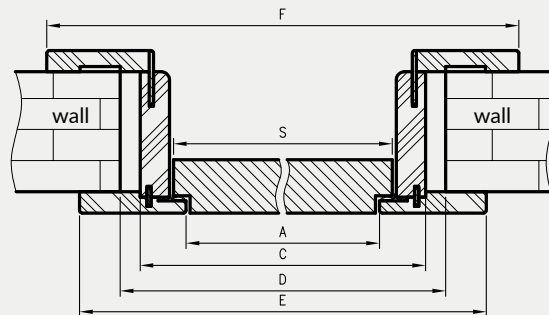

D - required width of wall opening



Estetic 1821 hinge

	A	C	D	E	F	S
60	625	694	724	785	834	644
70	725	794	824	885	934	744
80	825	894	924	985	1034	844
90	925	994	1024	1085	1134	944
100	1025	1094	1124	1185	1234	1044

Decor



white acrylic UV varnish - RAL 9003
 ecrú - RAL 9001
 latte - Flügger 4362, NCS S1505-Y50R
 ashen - RAL 7035

ADJUSTABLE TUNNEL

WITH ARCHITRAVE T63, T80 - TUN

Adjustable tunnel is a decorative cover of wall passage. It can be used as a separate solution or as an integral part of the sliding wall-mounted system NT.

The adjustable tunnel is a product which is, at first glance visually similar to adjustable door frames, but with a few differences:

- » there is no possibility to mount any hinges
- » there is no latch strike plate
- » there is no channel for a gasket different heights and spans of the front and rear architraves (values E and F in tables)



tunnel cross-section with T80 architrave

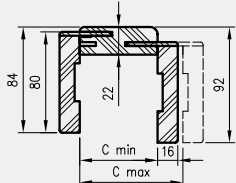

tunnel cross-section with T63 architrave

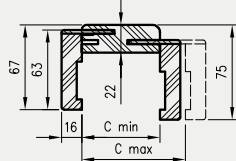

NOTE: To ensure the highest quality of painted tunnels, before painting process they are coated with special material which constitutes solid base.

vertical cross-section of adjustable tunnel with T80 architrave

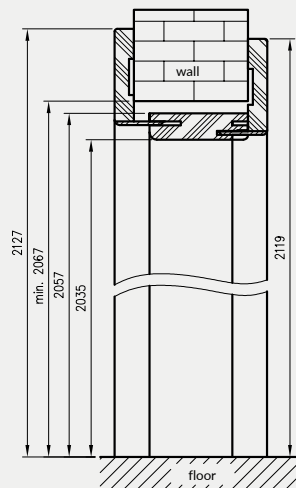

vertical cross-section of adjustable tunnel with architrave T63

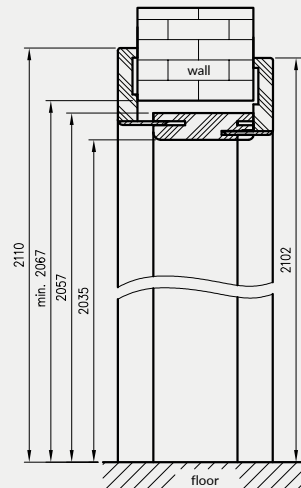

required height of wall opening 2067 mm

Double adjustable tunnel

symbol	120	130	140	150	160	170	180	190	200
A	1200	1300	1400	1500	1600	1700	1800	1900	2000
C	1244	1344	1444	1544	1644	1744	1844	1944	2044
D	1264	1364	1464	1564	1664	1764	1864	1964	2064
E*	1350	1450	1550	1650	1750	1850	1950	2050	2150
E**	1384	1484	1584	1684	1784	1884	1984	2084	2184
F*	1334	1434	1534	1634	1734	1834	1934	2034	2134
F**	1368	1468	1568	1668	1768	1868	1968	2068	2168

Adjustable tunnel cross section

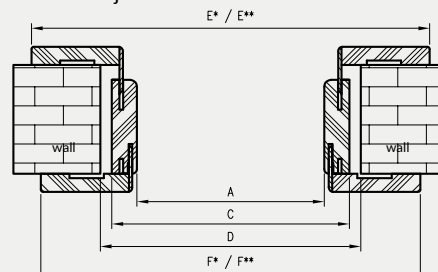

OPTIONS AVAILABLE WITH EXTRA CHARGE

Tunnel for double leaf door: +30%

Single adjustable tunnel

symbol	60	70	80	90	100
A	602	702	802	902	1002
C	646	746	846	946	1046
D	664	764	864	964	1064
E*	752	852	952	1052	1152
E**	786	886	986	1086	1186
F*	736	836	936	1036	1136
F**	770	870	970	1070	1170

D - required width of wall opening
*refers to Adjustable Tunnel with T63
**refers to Adjustable Tunnel with T80 architrave



UNI 10 - white

Price of the set = price of two vertical beams + price of the horizontal beam with architrave panels

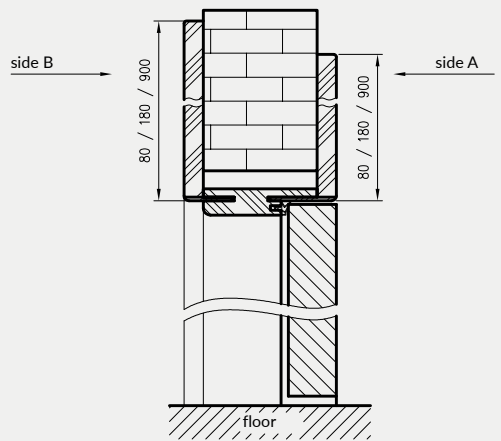

Decor				
	white	ecru	latte	ashen

white acrylic UV varnish - RAL 9003
 ecru - RAL 9001
 latte - Flugger 4362, NCS S1505-Y50R
 ashen - RAL 7035

NON-REBATED ADJUSTABLE DOOR FRAMES

WITH ARCHITRAVE PANELS

CONSTRUCTION

Adjustable non-rebated door frame is made of a high-quality wood-based MDF board. On its visual side it is entirely coated with a foil and in next step is painted. Its construction allows to be used with door leaf with the thickness of 40 mm and its design allows to be used on walls with span 75-320. On horizontal beam there are made special architrave panels in three optional dimensions: 80 mm, 180 mm or 900 mm.

APPLICATION

Adjustable non-rebated door frame with architrave panels can be used with all DRE non-rebated painted collections.

SET CONTAINS

Main beam with wide architrave (80 mm) with small rounding angles of the cross-section profile (R2), horizontal beam with architrave panels in 3 optional dimensions, door gasket, a set of hinges, all necessary components for the installation of door frames in accordance with the supplied instruction. Door frames are packed in cardboard boxes.



horizontal cross-section of the lintel

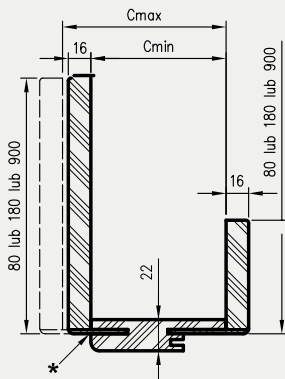

cross-section of vertical beam

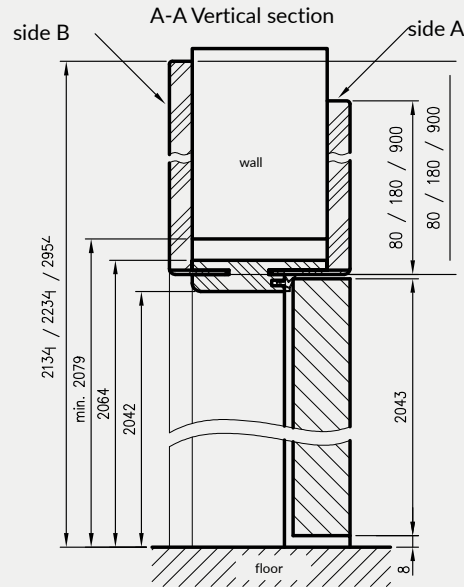
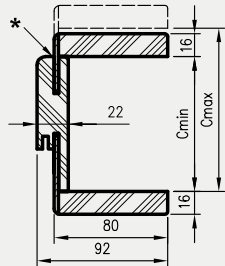

Required height of the wall opening = 2079 mm

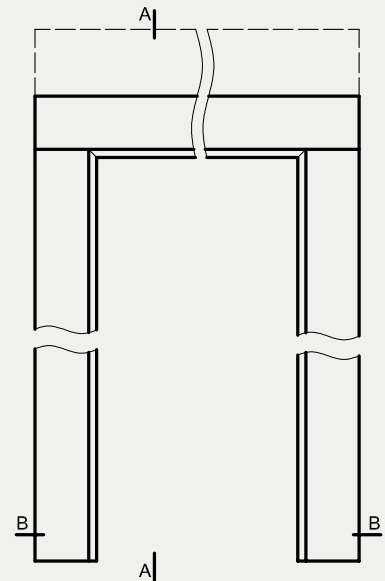

B-B Horizontal cross-section

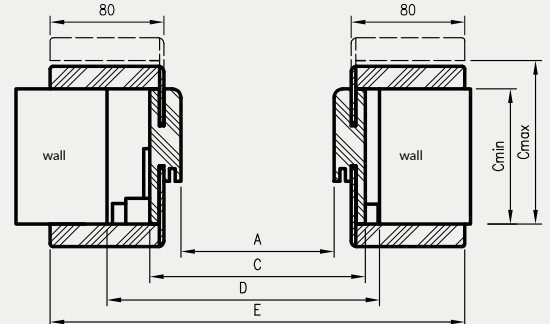

D - required width of wall opening

for single-leaf doors

	A	C	D	E
60	627	671	711	811
70	727	771	811	911
80	827	871	911	1011
90	927	971	1011	1111
100	1027	1071	1111	1211

*NOTE: 075-095 door frame has a different cross-section, shallow milling for architrave, for a 75-89 mm wall thickness, it will be necessary to shorten tongue of the masking architrave.

** - third hinge, option at extra charge

EXTENSION PANELS

APPLICATION

Extension panel it is a component of decorative cover of wall passage but also it can be used as extension to install door frames in walls, which are thicker than 320mm. Panel is an extension of middle parts of adjustable door frames and adjustable tunnels. It might be used together with architraves from previous orders of door frames and adjustable tunnels with connection of main beams at 45 degree. Extension panels with variable heights are available only in Cell and CPL group.

SET CONTAINS

- » two vertical beams
- » horizontal beam
- » three connecting tongues
- » accessories used to connect main beams

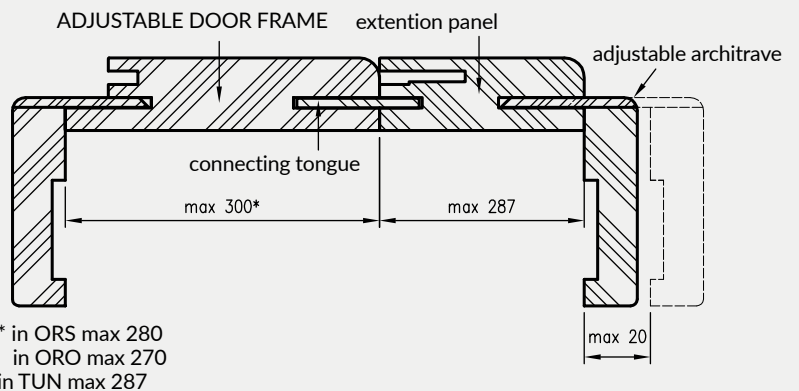
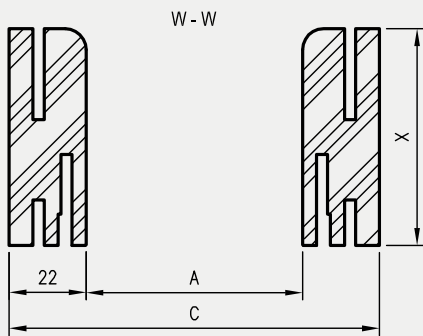
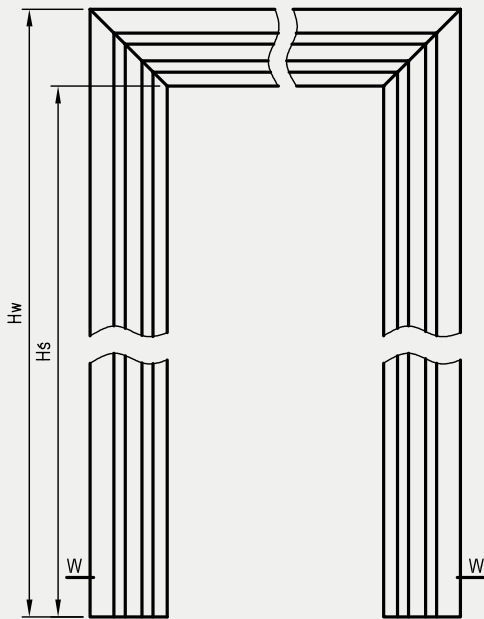

options of the width of panels cross-section

X	062	082	107	127	147	167	187	207	227	247	267	287
---	-----	-----	-----	-----	-----	-----	-----	-----	-----	-----	-----	-----

EXTENSION PANELS

Dimensions of extension panels OR - adjustable door frames for rebated doors

height options					for single-leaf doors							for double-leaf doors										
	PL	198x	211x	224X	"60"	"70"	"80"	"90"	"100"	"110"	"100d"	"110d"	"120"	"130"	"140"	"150"	"160"	"170"	"180"	"190"	"200"	
HŚ	2029	1969	2096	2226	A	602	702	802	902	1002	1102	1035	1135	1235	1335	1435	1535	1635	1735	1835	1935	2035
hw	2051	1991	2118	2248	C	646	746	846	946	1046	1146	1079	1179	1279	1379	1479	1579	1679	1779	1879	1979	2079

Dimensions of the ORB extension panels connected at 45 degree - non-rebated adjustable door frames for non-rebated doors connected at 45 degree

height options					for single-leaf doors						for double-leaf doors						
	PL	198x	211x	224X	"60"	"70"	"80"	"90"	"100"	"120"	"130"	"140"	"150"	"160"	"170"	"180"	
HŚ	2042	1982	2109	2239	A	627	727	827	927	1027	1274	1374	1474	1574	1674	1774	1874
hw	2064	2004	2131	2261	C	671	771	871	971	1071	1318	1418	1518	1618	1718	1818	1918

Dimensions of TUN extension panels - adjustable tunnels

		for single-leaf doors						for double-leaf doors								
	PL	"60"	"70"	"80"	"90"	"100"	"120"	"130"	"140"	"150"	"160"	"170"	"180"	"190"	"200"	
HŚ	2035	A	602	702	802	902	1002	1200	1300	1400	1500	1600	1700	1800	1900	2000
hw	2057	C	646	746	846	946	1046	1244	1344	1444	1544	1644	1744	1844	1944	2044

Dimensions of the ORC extension panels - adjustable door frames for glass doors

	PL	"60"	"70"	"80"	"90"	
HŚ	2035	A	600	700	800	900
hw	2057	C	644	744	844	944

Dimensions of the ORS extension panels - adjustable door frames for folding doors

	PL	"80"	"90"	"100"	
HŚ	2029	A	806	906	1006
hw	2051	C	850	950	1050

Dimensions of ORO extension panels - adjustable door frames for door leaves with inverted rebate

	PL	"60"	"70"	"80"	"90"	"100"	
HŚ	2066	A	650	750	850	950	1050
hw	2088	C	694	794	894	994	1094

OPTIONS AVAILABLE WITH EXTRA CHARGE

panel for double doors: + 30%

STEEL FIXED DOOR FRAMES

CONSTRUCTION

metal door frames are made of steel low carbon sheet with 1,5 mm thickness, secured with lacquered, organic protective surface. Door frame consist of two vertical elements: latch plate beam and beam with the hinges (in door frame for double leaf door there are two vertical elements with the hinges) and lintel. Those elements are permanently welded together. Vertical beams with hinges are equipped with sockets for the hinges, while beams for latch plates are equipped with cuts for locks tongue and cuts for dead bolt of dedicated door leaf lock (set includes gasket). Door frame profile, its dimentions, equipment and available colours depends on selected options - type of the door leaf.

APPLICATION / TYPES OF OSS DOOR FRAMES (FIXED STEEL DOOR FRAMES)

OSS_STAND	OSS For rebated interior doors
OSSB_STAND	OSS for non-rebated interior doors
OSS_GLASS	OSS for interior glass doors
OSS_ENTER	OSS for the Enter door, Enter Akustik, Revos
OSS_SOLID	OSS for solid doors
OSS_SOLID_RC2	OSS for Solid RC2 door leaf
OSS_ATHOS	OSS for Athos door leaf
OSS_FORCA	OSS for Forca or Forca B door leaf
OSS_OLIMP_EI30	OSS for Olimp EI-30 door leaf

All frames are designed to be mounted on the finished floor.



STANDARD OPTIONS IN OSS

- » sockets for 2, 3, 4 or 6 hinges
- » socket for latch plate of main lock

STANDARD OPTIONS IN OSSB

- » sockets for 2 or 4 hinges
- » magnetic lock latch

STANDARD OPTIONS IN OSS GLASS

- » sockets for 2 hinges
- » socket for latch plate of main lock

STANDARD OPTIONS IN OSS ENTER

- » sockets for 3 hinges
- » socket for main lock or additionally for upper lock

STANDARD OPTIONS IN OSS SOLID

- » sockets for 3 hinges
- » additional sockets for anti-thrust bolts
- » sockets for latch bolts of multi-point lock used in SOLID model

STANDARD OPTIONS IN OSS SOLID RC2

- » sockets for 3 triple hinges
- » additional sockets for anti-thrust bolts
- » sockets for latch bolts of multi-point lock used in SOLID model

STANDARD OPTIONS IN OSS ATHOS, FORCA, FORCA B

- » sockets for 3 triple hinges
- » additional sockets for anti-thrust bolts
- » sockets for latch plates of five point mortise lock (FORCA, FORCA B)
- » socket for latch plate of main lock (ATHOS)

STANDARD OPTIONS FOR OSS OLIMP EI30

- » socket for latch plate of main lock
- » sockets for 3 or 6 triple hinges (6 for double-leaf frames)

AVAILABLE COLOURS

Door frame is powder coated in two gloss scale (mat / low structure or semi-gloss / plain). There are available colours:



*** beige colour is available only in semi-gloss

STEEL FIXED DOOR FRAMES

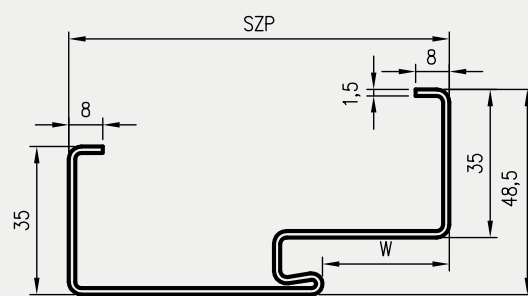
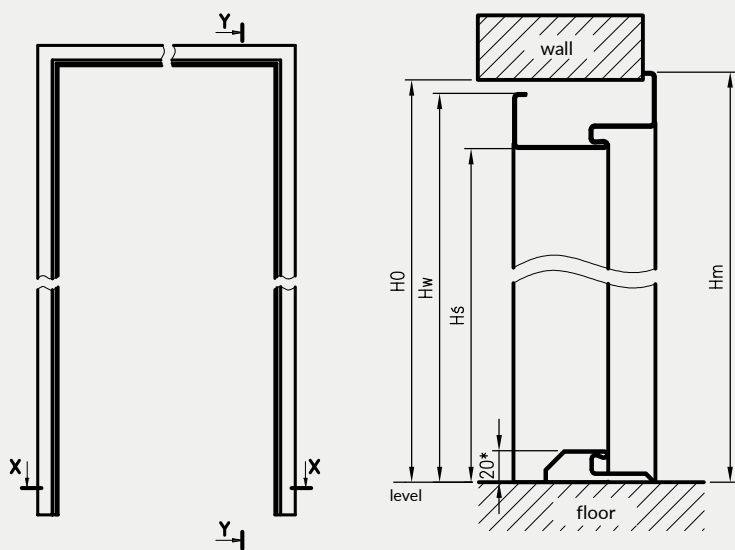

type of the door frame	H0	H _S	hw	hm	W	SZP
OSSB STAND	2084	2040,5	2075,5	2089	46	106
OSS STAND	2071	2027,5 *	2062,5	2076	30	90
OSS for ENTER						
OSS SOLID						
OSS SOLID RC2						
OSS FOR GLASS DOORS	2077	2033,5	2068,5	2082	30	90
OSS ATHOS	2073	2029,5 *	2064,5	2078	38	117
OSS FORCA						
OSS OLIMP EI30						
OSS OLIMP EI30	2070	2025,5	2060,5	2074		

H0 - height of the wall passage

H_S - height of the door frame passage

* - with the use of a steel threshold - the actual height of the door frame passage will be reduced by 20mm from the floor

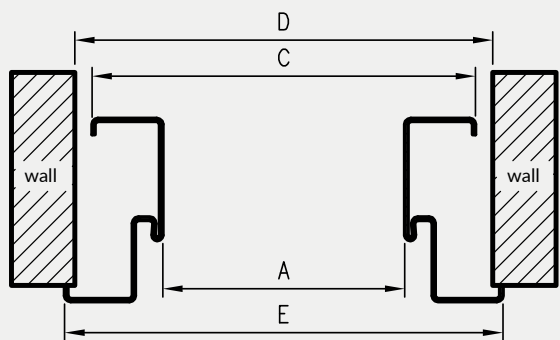

D - width of the assembly hole

OSS width dimensions

symbol width.	A	C	D	E	OSS STAND	OSS glass doors	OSS ENTER	OSS SOLID	OSS SOLID RC2	OSS ATHOS	OSS OLIMP EI30	OSS FORCA
"60"	600	670	687	697	●	●						
"70"	700	770	787	797	●	●	●					
"80"	800	870	887	897	●	●	●	●	●	●	●	●
"90"	900	970	987	997	●	●	●	●	●	●	●	●
"90E"	904	974	991	1001	●		●	●	●		●	●
"90E"	915	985	1002	1012						●	●	●
"100"	1000	1070	1087	1097	●		●	●	●	●	●	●
"110"	1100	1170	1187	1197	●		●			●	●	

**** - investment dimension "90E" different for technical and remaining doors

OSS OLIMP EI30 for double leaf doors

symbol width.	A	C	D	E
"160"	1637	1707	1724	1734
"170"	1737	1807	1824	1834
"180"	1837	1907	1924	1934
"190"	1937	2007	2024	2034
"200"	2037	2107	2124	2134
"210"	2137	2207	2224	2234
"220"	2237	2307	2324	2334

OSSB STAND for single leaf door

symbol width.	A	C	D	E
"60"	624	694	711	721
"70"	724	794	811	821
"80"	824	894	911	921
"90"	924	994	1011	1021
"100"	1024	1094	1111	1121

OSS STAND dimensions for double leaf doors

symbol width.	A	C	D	E
"100D"	1032	1102	1119	1129
"110D"	1132	1202	1219	1229
"120"	1232	1302	1319	1329
"130"	1332	1402	1419	1429
"140"	1432	1502	1519	1529
"150"	1532	1602	1619	1629
"160"	1632	1702	1719	1729
"170"	1732	1802	1819	1829
"180"	1832	1902	1919	1929
"190"	1932	2002	2019	2029
"200"	2032	2102	2119	2129

OSSB STAND for double leaf doors

symbol width.	A	C	D	E
"120"	1271	1341	1358	1368
"130"	1371	1441	1458	1468
"140"	1471	1541	1558	1568
"150"	1571	1641	1658	1668
"160"	1671	1741	1758	1768
"170"	1771	1841	1858	1868
"180"	1871	1941	1958	1968

ADJUSTABLE METAL DOOR FRAME

The essence of the adjustable door frame is that its construction allows to instal door frame, without additional finishing work. Angular architrave allows for additional adjustment in the range + 30mm.

APPLICATION / TYPES OF OSR (ADJUSTABLE STEEL DOOR FRAMES)

OSR_STAND	OSR For rebated interior doors
OSRB_STAND	OSR for non-rebated interior doors
OSR_GLASS	OSR For interior glass doors
OSR_ENTER	OSR for the door leaf Enter, Enter Akustik, Revos
OSR_SOLID	OSS for solid doors
OSR_SOLID_RC2	OSR for Solid RC2
OSR_ATHOS	OSR for Athos door leaf
OSR_FORCA	OSR for Forca or Forca B door leaf
OSR_OLIMP	OSS for Olimp EI-30 door leaf

All frames are designed to be mounted on the finished floor.
The door frames can be used for walls 95-305 mm thick or 103-313 mm thick in the case of OSR FORCA, OSR ATHOS and OSR OLIMP. For a selected wall thickness, the appropriate option of the frame should be selected, the range of which Cmin - Cmax will include the thickness of the finished wall



CONSTRUCTION

metal door frames are made of steel low carbon sheet with 1,5 mm thickness, powder painted. Door frame consist of two vertical elements: latch plate beam and beam with the hinges (in door frame for double leaf door there are two vertical elements with the hinges) and lintel. Those elements are permanently welded together. Vertical beams with hinges are equipped with sockets for the hinges, while beams for latch plates are equipped with cuts for locks tongue and cuts for dead bolt of dedicated door leaf lock (set includes gasket). External and internal side of the door frame is secured with lacquered, organic protective surface. Door frame profile, its dimentions, equipment and available colours depends on selected options - type of the door leaf.

STANDARD OPTIONS IN OSR STAND

- » sockets for 2, 3, 4 or 6 hinges
- » socket for latch plate of main lock

STANDARD OPTIONS IN OSRB STAND

- » sockets for 2 or 4 hinges
- » magnetic lock latch

STANDARD OPTIONS IN OSR GLASS DOORS

- » sockets for 2 hinges
- » socket for latch plate of main lock

STANDARD OPTIONS IN OSR ENTER

- » sockets for 3 hinges
- » socket for main lock or additionally for upper lock

STANDARD OPTIONS IN OSR SOLID

- » sockets for 3 hinges
- » additional sockets for anti-thrust bolts
- » sockets for latch bolts of multi-point lock used in SOLID model

STANDARD OPTIONS IN OSR SOLID RC2

- » sockets for 3 triple hinges
- » additional sockets for anti-thrust bolts
- » sockets for latch bolts of multi-point lock used in SOLID model

STANDARD OPTIONS IN OSR ATHOS, FORCA, FORCA B

- » sockets for 3 triple hinges
- » additional sockets for anti-thrust bolts
- » sockets for latch plates of five point mortise lock (FORCA, FORCA B)
- » socket for latch plate of main lock (ATHOS)

STANDARD OPTIONS FOR OSR OLIMP EI30

- » sockets for 3 threefold hinges
- » socket for latch plate of main lock

AVAILABLE COLOURS

Door frame is powder coated in two gloss scale (mat / low structure or semi-gloss / plain). There are available colours:

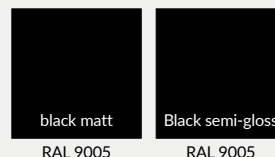

*** beige colour is available only in semi-gloss

ADJUSTABLE METAL DOOR FRAME

REBATED

adjustable steel rebated door frames - dimensions

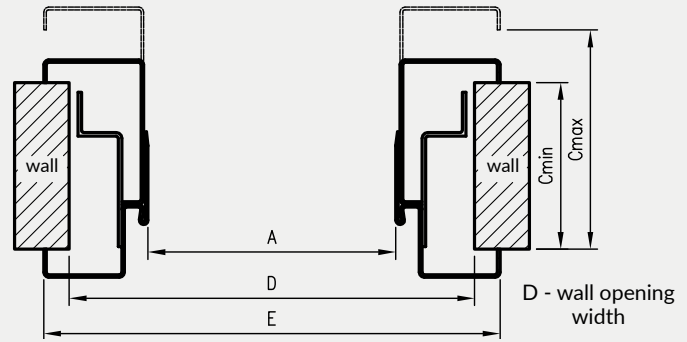
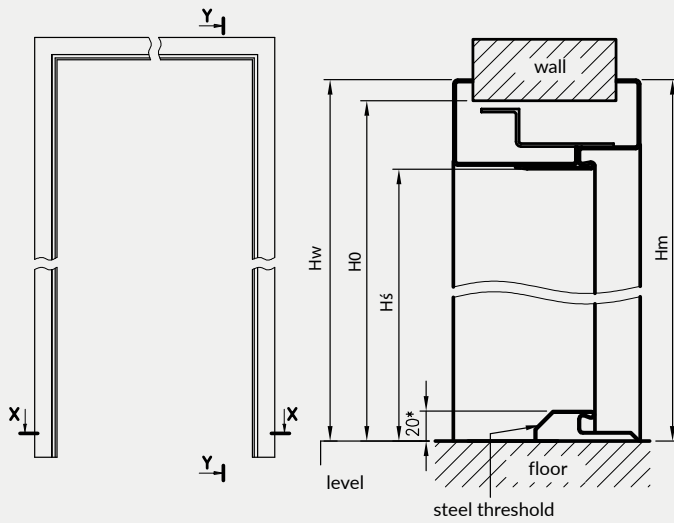

* - with the use of a steel threshold - the actual height of the door frame passage will be reduced by 20mm from the floor

OSR door frame profile with the T57 architrave

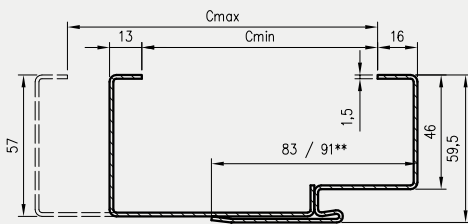

** 91 for OSS ATHOS, OSR FORCA, OSR FORCA B and OSR OLIMPEI 30

OSR width dimensions

symbol width.	A	D	E	OSR_STAND	OSR_GLASS DOORS	OSR_ENTER	OSR_SOLID	OSR_SOLID_RC2	OSR_ATHOS	OSS FOR OLIMP EI-30 DOOR LEAF	OSR_FORCA
"60"	600	690	719	•	•						
"70"	700	790	819	•	•	•					
"80"	800	890	919	•	•	•	•	•	•	•	•
"90"	900	990	1019	•	•	•	•	•	•	•	•
"90E"	904	994	1023	•	•	•	•	•			
"90E"	915	1005	1034						•	•	•
"100"	1000	1090	1119	•	•	•	•	•	•	•	•
"110"	1100	1190	1219	•	•	•	•	•	•	•	•

**** - investment dimension "90E" different for technical and remaining doors

OSR STAND dimensions for double leaf doors

symbol width.	A	D	E
"100D"	1032	1122	1151
"110D"	1132	1222	1251
"120"	1232	1322	1351
"130"	1332	1422	1451
"140"	1432	1522	1551
"150"	1532	1622	1651
"160"	1632	1722	1751
"170"	1732	1822	1851
"180"	1832	1922	1951
"190"	1932	2022	2051
"200"	2032	2122	2151

type of the door frame	H0	Hs	hw	hm	W
OSR_STAND	2073	2027,5 *	2088	2087	30
OSR_ENTER					
OSR_SOLID					
OSR_SOLID_RC2					
OSR_GLASS DOORS	2079	2033,5	2094	2093	30
OSR_ATHOS	2073	2027,5 *	2088	2087	38
OSR_FORCA					
OSR OLIMP EI30					

H0 - height of the wall passage

Hs - height of the door frame passage

* - with the use of a steel threshold - the actual height of the door frame passage will be reduced by 20mm from the floor

ADJUSTABLE METAL DOOR FRAME

NON-REBATED

adjustable steel non-rebated door frames- dimensions

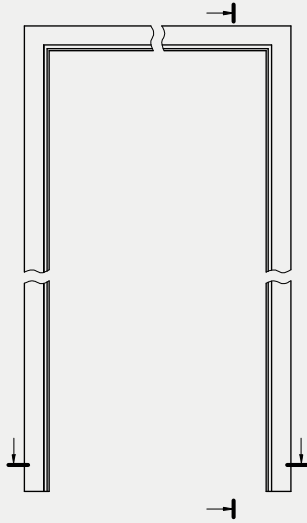

Vertical section of the OSRB

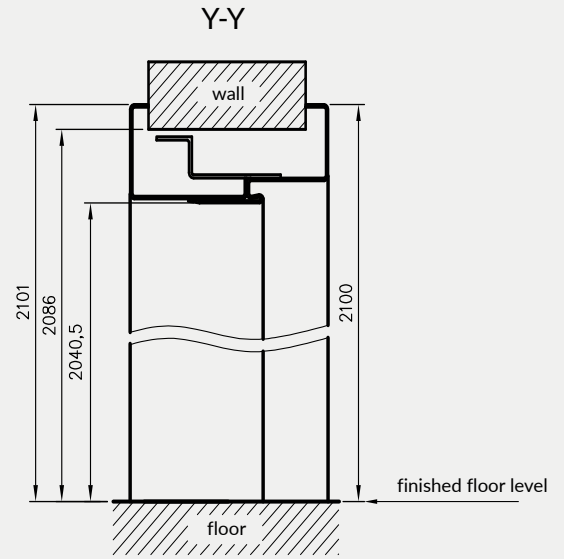

OSRB horizontal cross-section

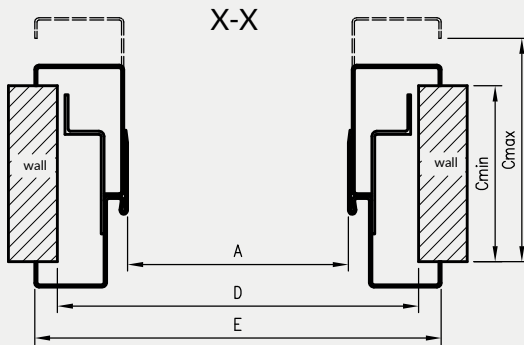

D - width of the assembly hole

adjustable steel non-rebated door frame profile

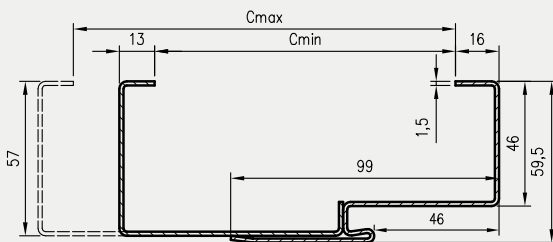

Dimensions for single leaf doors

symbol width.	A	D	E
"60"	624	714	743
"70"	724	814	843
"80"	824	914	943
"90"	924	1014	1043
"100"	1024	1114	1143

Dimensions for double leaf doors

symbol width.	A	D	E
"120"	1271	1361	1390
"130"	1371	1461	1490
"140"	1471	1561	1590
"150"	1571	1661	1690
"160"	1671	1761	1790
"170"	1771	1861	1890
"180"	1871	1961	1990

Note: Extra charge for selfcloser reinforcement

HYBRID STEEL DOOR FRAMES

CONSTRUCTION:

Hybrid steel door frame - it is an innovative solution in our sale offer, which combines solidity of metal construction with additional functionality it allows to finish wall passage by using door frame elements made of MDF, coated with CPL laminate. Hybrid metal door frame is a combination of metal door frame with fixed width, MDF panel available in 11 optional variants of width and masking architrave. This solution allows to finish walls with thickness ranging between 137-337 mm (145 - 345 for technical door leaves), and additional possible adjustment up to 20 mm.

Door frame profile, dimensions and equipment depend on selected option - door leaf model.

APPLICATION / TYPES OF OSH DOOR FRAMES (HYBRID STEEL DOOR FRAMES)

OSH_STAND	OSH for rebated interior door leaf
OSHB_STAND	OSH for non-rebated interior doors
OSH_GLASS	OSH For interior glass doors
OSH_ENTER	OSH for the door Enter, Enter Akustik, Revos
OSH_SOLID	OSH for Solid doors
OSH_SOLID_RC2	OSH for Solid RC2
OSH_ATHOS	OSH for the Athos door leaf
OSH_FORCA	OSH for Forca or Forca B door leaf
OSH_OLIMP	OSH for Olimp EI-30 door leaf

All frames are designed to be mounted on the finished floor.



STANDARD OPTIONS IN OSH STAND

- » sockets for 2 or 3 hinges
- » socket for latch plate of main lock
- In the door frame for double leaf doors - sockets for 4 or 6 hinges

STANDARD OPTIONS IN OSHB STAND

- » sockets for 2 or 4 hinges
- » magnetic lock latch

STANDARD OPTIONS IN OSH GLASS

- » sockets for 2 hinges
- » socket for latch plate of main lock

STANDARD OPTIONS IN OSH ENTER

- » sockets for 3 hinges
- » socket for main lock or additionally for upper lock

STANDARD OPTIONS IN OSH SOLID

- » sockets for 3 hinges
- » additional sockets for anti-thrust bolts
- » sockets for latch bolts of multi-point lock used in SOLID model

STANDARD OPTIONS IN OSH SOLID RC2

- » sockets for 3 triple hinges
- » additional sockets for anti-thrust bolts
- » sockets for latch bolts of multi-point lock used in SOLID model

STANDARD OPTIONS IN OSH ATHOS, FORCA

- » sockets for 3 triple hinges
- » additional sockets for anti-thrust bolts
- » sockets for latch plates of five point mortise lock (FORCA, FORCA B)
- » socket for latch plate of main lock (ATHOS)

STANDARD OPTIONS FOR OSH OLIMP EI30

- » socket for latch plate of main lock
- » sockets for 3 triple hinges

AVAILABLE COLOURS

Door frame is powder coated in two gloss scale (matt / low structure or semi-gloss / plain). There are available colours:

white matt RAL 9003	light gray matt RAL 7047	dark gray matt RAL 7024	brown matt RAL 8017	white semigloss RAL 9003	light gray semi-gloss RAL 7047	Dark gray semi-gloss RAL 7024	brown semi-gloss RAL 8017	beige semi-gloss *** RAL 1001
------------------------	-----------------------------	----------------------------	------------------------	-----------------------------	-----------------------------------	----------------------------------	------------------------------	-------------------------------------

black matt RAL 9005	Black semi-gloss RAL 9005
------------------------	------------------------------

Adjustable panel with a masking architrave coated with CPL laminate from the list below:

CPL Lami-nate	white	milky white	ashen	dark gray	concrete 2	gray oak	welsh oak
	acacia	celini walnut	walnut	honey oak	chestnut	roasted walnut	

*** beige colour is available only in semi-gloss

HYBRID STEEL DOOR FRAMES

REBATED

Hybrid steel rebated door frames - dimensions

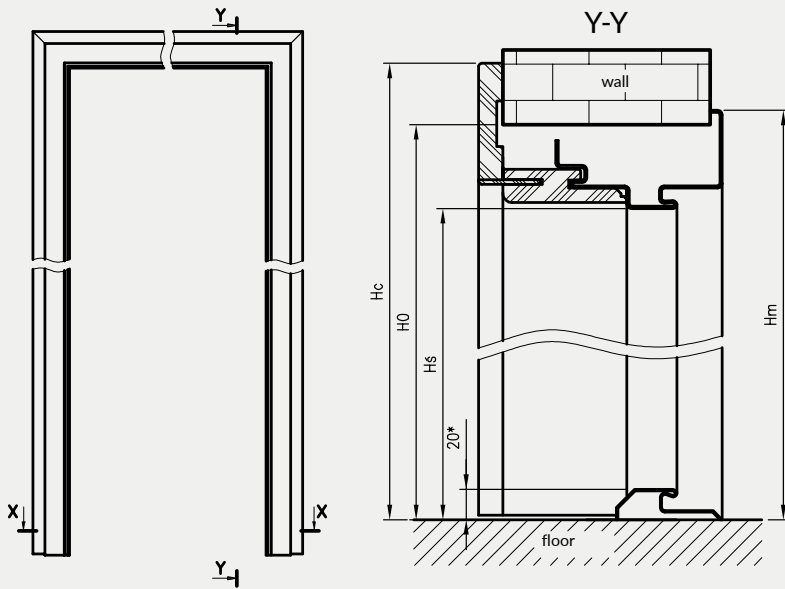

type of the door frame.	H0	Hs	hm	HC
OSH_STAND	2083	2027,5*	2092,5	2124
OSH_ENTER				
OSH_SOLID				
OSH SOLID RC2	2089	2033,5	2098,5	2130
OSH_ATHOS	2085	2029,5*	2094,5	2126
OSH_FORCA				
OSH_OLIMP	2081	2025,5	2090	2122

H0 - height of the wall passage

Hs - height of the door frame passage

* - with the use of a steel threshold - the actual height of the door frame passage will be reduced by 20mm from the floor

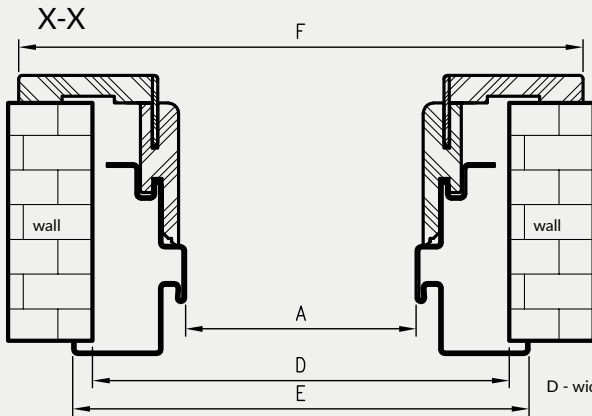

Dimensions of the door frame width

symbol width.	A	D	E	F	OSH_STAND	OSH glass doors	OSH_ENTER	OSH_SOLID	OSH SOLID RC2	OSH_ATHOS	OSH_FORCA	OSH FOR OLIMP EI-30
"60"	600	710	730	792	•	•						
"70"	700	810	830	892	•	•	•					
"80"	800	910	930	992	•	•	•	•	•	•	•	•
"90"	900	1010	1030	1092	•	•	•	•	•	•	•	•
"90E"	904	1014	1034	1096	•		•	•	•		•	•
"90E"	915	1025	1045	1107						•	•	•
"100"	1000	1110	1130	1192	•		•	•	•	•	•	•
"110"	1100	1210	1230	1292	•		•			•		•

**** - investment dimension "90E" different for technical and remaining doors

OSH STAND dimensions for double leaf doors

symbol width.	A	D	E	F
"100D"	1032	1142	1162	1224
"110D"	1132	1242	1262	1324
"120"	1232	1342	1362	1424
"130"	1332	1442	1462	1524
"140"	1432	1542	1562	1624
"150"	1532	1642	1662	1724
"160"	1632	1742	1762	1824
"170"	1732	1842	1862	1924
"180"	1832	1942	1962	2024
"190"	1932	2042	2062	2124
"200"	2032	2142	2162	2224

door frame profile

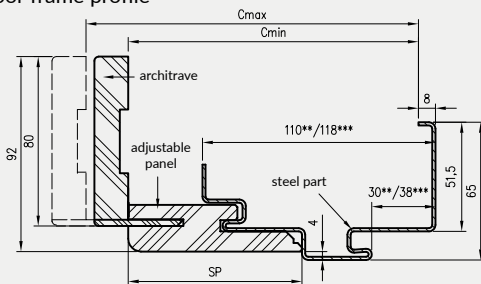

Select the appropriate option of the adjustable panel with masking architrave (Cmin) for a specific wall thickness

*** - dimensions for OSH ATHOS, OSH FORCA and OSH OLIMP EI 30

** - dimensions for remaining OSH frames

Door Frame price = price of the metal part + price of an adjustable panel with a architrave

HYBRID STEEL DOOR FRAMES

NON-REBATED

Hybrid steel non-rebated door frames - dimensions

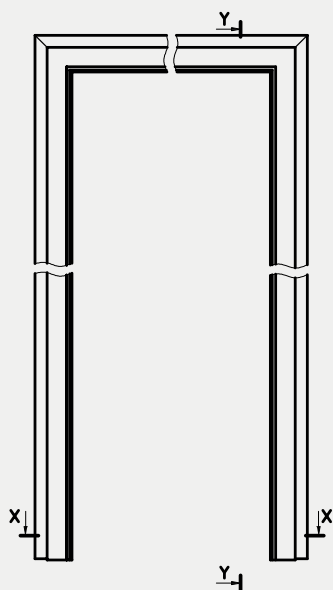

Y-Y Vertical cross-section of OSHB

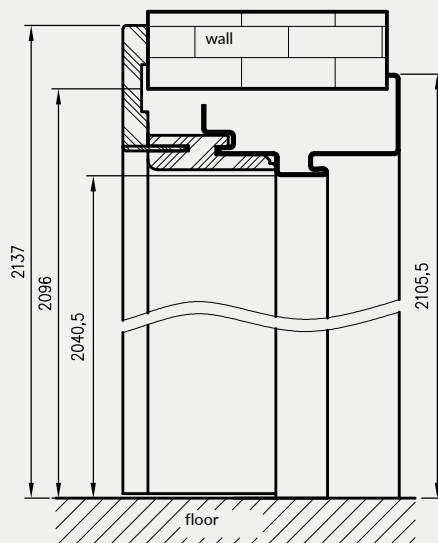

OSHB horizontal cross-section X-X

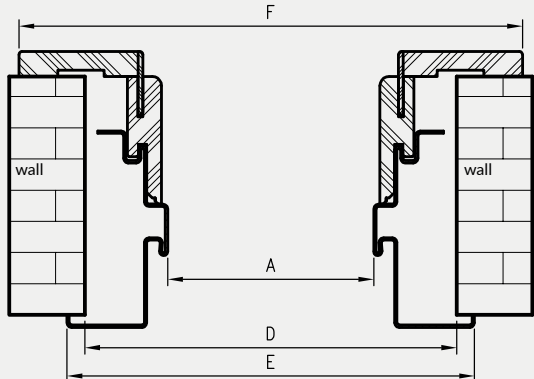

hybrid steel non-rebated door frame profile

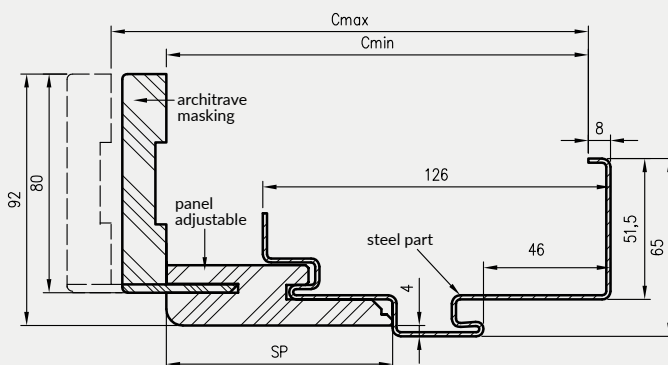

D - width of the assembly hole

Select the appropriate option of the adjustable panel with masking architrave (Cmin) for a specific wall thickness

Dimensions for single leaf doors

symbol width.	A	D	E	F
"60"	624	734	754	816
"70"	724	834	854	916
"80"	824	934	954	1016
"90"	924	1034	1054	1116
"100"	1024	1134	1154	1216

Dimensions for double leaf doors

symbol width.	A	D	E	F
„120"	1271	1381	1401	1463
„130"	1371	1481	1501	1563
„140"	1471	1581	1601	1663
„150"	1571	1681	1701	1763
„160"	1671	1781	1801	1863
„170"	1771	1881	1901	1963
„180"	1871	1981	2001	2063

SMALL ANGULAR STEEL DOOR FRAMES

CONSTRUCTION:

The steel door frames are made of 1,2 mm thick low-carbon steel sheet, protected with a varnish, organic protective coating. The door frame consists of two stands: latch strike plate and hinge, and a lintel, permanently connected by welding. Hinged racks are equipped with hinge sockets (2-3 pcs.), while hook racks have cutouts for the tongue and latches of the dedicated door leaf lock (the set includes a covering gasket).

APPLICATION

Small Angular Steel Door Frame - door frame designed for rebated interior doors

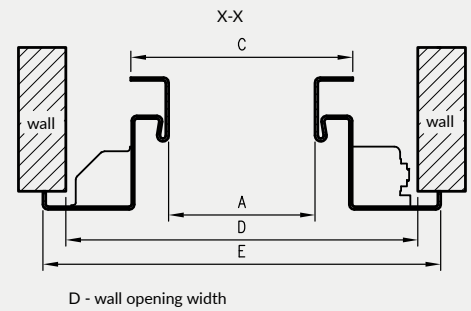
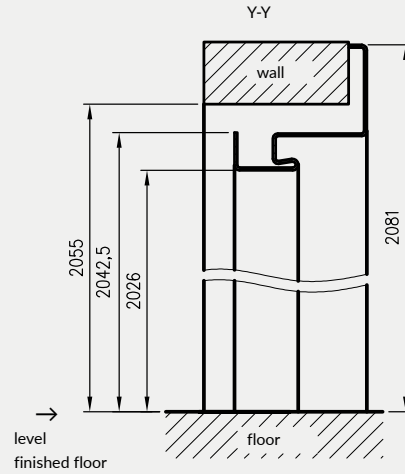
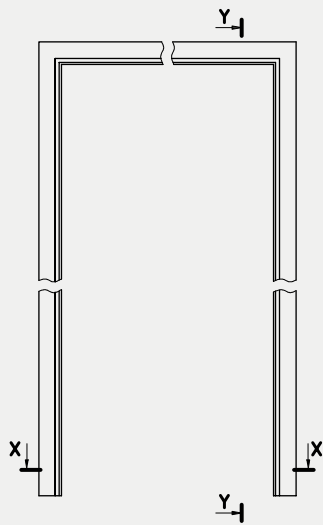

small angular steel door frame profile

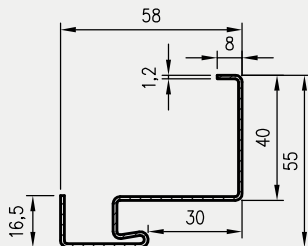

Dimensions for single leaf doors

symbol width.	A	C	D	E
"60"	600	633	690	710
"70"	700	733	790	810
"80"	800	833	890	910
"90"	900	933	990	1010
"90E"	904	937	994	1014
"100"	1000	1033	1090	1110

AVAILABLE COLOURS

Door frame is powder coated in two gloss scale (matt / low structure or semi-gloss / plain). There are available colours:

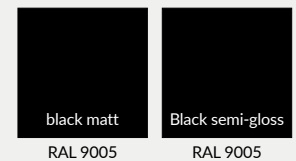
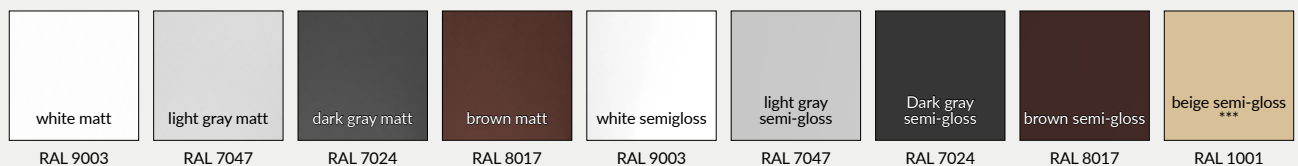

*** beige colour is available only in semi-gloss

DOOR HANDLES



handle MEDA - shiny chrome
inserts in DRE-Cell, 3D and CPL colours



backplate for
simple key



backplate for
cylinder lock



backplate for
toilet lock

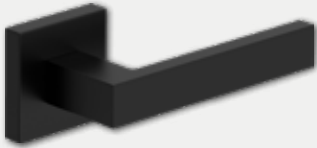

QUBIK handle - black with antibacterial coating *



backplate for
simple key



backplate for
cylinder lock



backplate for
toilet lock*



CUBE SLIM handle - brushed chrome



backplate for
simple key



backplate for
cylinder lock



backplate for
toilet lock



CUBE SLIM handle - shiny brass



backplate for
simple key



backplate for
cylinder lock



backplate for
toilet lock



TOTAL door handle - brushed nickel matt



backplate for
simple key



backplate for
cylinder lock



backplate for
toilet lock



IBIZA door handle - black matt



backplate for
simple key



backplate for
cylinder lock



backplate for
toilet lock



CUBE handle - glossy chrome



backplate for
simple key



backplate for
cylinder lock



backplate for
toilet lock



CUBE door handle - brushed nickel



backplate for
simple key



backplate for
cylinder lock



backplate for
toilet lock

* - the handle and the toilet knobs are covered with an antibacterial coating

DOOR HANDLES



CUBE door handle - black matt



backplate for simple key



backplate for cylinder lock



backplate for toilet lock



MONDO door handle - satin nickel



backplate for simple key



backplate for cylinder lock



backplate for toilet lock



TREND door handle - satin nickel



backplate for simple key



backplate for cylinder lock



backplate for toilet lock



LINEA door handle - shiny chrome



backplate for simple key



backplate for cylinder lock



backplate for toilet lock



LINEA door handle - nickel satin



backplate for simple key



backplate for cylinder lock



backplate for toilet lock



QUANTA Fit door handle - brushed brass



backplate for simple key



backplate for cylinder lock



backplate for toilet lock



BELLA SLIM door handle - glossy brass



backplate for simple key lock



backplate for cylinder lock



backplate for toilet lock



ZORBA door handle - shiny chrome/satin



backplate for simple key



backplate for cylinder lock



backplate for toilet lock

DOOR HANDLES

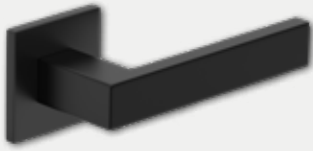

QUIK Fit door handle - black



backplate for simple key



backplate for cylinder lock



backplate for toilet lock



NOVA door handle - stainless steel



backplate for simple key



backplate for cylinder lock



backplate for toilet lock



PROXIMA door handle - stainless steel



backplate for simple key



backplate for cylinder lock



backplate for toilet lock



TOPAZ door handle - stainless steel



backplate for simple key



backplate for cylinder lock



backplate for toilet lock



TOPAZ door handle - stainless steel, black matt



backplate for simple key



backplate for cylinder lock



backplate for toilet lock



JOWISZ door handle - stainless steel



backplate for simple key



backplate for cylinder lock



backplate for toilet lock

NEW



LUNA SLIM door handle - brushed chrome



backplate for simple key



backplate for cylinder lock



backplate for toilet lock

NEW



LUNA door handle SLIM - shiny brass



backplate for simple key



backplate for cylinder lock



backplate for toilet lock

DOOR HANDLES



IBIZA door handle - graphite/chrome



backplate for simple key



backplate for cylinder lock



backplate for toilet lock



IBIZA door handle - nickel satin



backplate for simple key



backplate for cylinder lock



backplate for toilet lock



IBIZA door handle - shiny chrome



backplate for simple key



backplate for cylinder lock



backplate for toilet lock

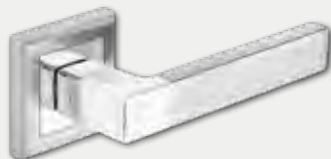

BETA door handle - nickel satin



backplate for simple key



backplate for cylinder lock



backplate for toilet lock



EUROPA door handle - nickel satin



backplate for simple key



backplate for cylinder lock



backplate for toilet lock



TOMA door handle - black



backplate for simple key



backplate for cylinder lock



backplate for toilet lock

NEW



STARK Fit door handle - black



backplate for simple key



backplate for cylinder lock



backplate for toilet lock



WARNA door handle - satin nickel



backplate for simple key



backplate for cylinder lock



backplate for toilet lock

DOOR HANDLES



WEGA door handle - black matt



backplate for simple key



backplate for cylinder lock



backplate for toilet lock



ARCTUS door handle - satin nickel



backplate for simple key



backplate for cylinder lock



backplate for toilet lock



ALVA LUX door handle - black matt



backplate for simple key



backplate for cylinder lock



backplate for toilet lock



PEM LUX door handle - glossy chrome



backplate for simple key



backplate for cylinder lock



backplate for toilet lock



AS LUX door handle - titanium



backplate for simple key



backplate for cylinder lock



backplate for toilet lock



LEA LUX door handle - glossy chrome



backplate for simple key



backplate for cylinder lock



backplate for toilet lock



FOKUS door handle - nickel satin velvet



backplate for simple key



backplate for cylinder lock



backplate for toilet lock



JANE door handle - varnished nickel



backplate for simple key



backplate for cylinder lock



backplate for toilet lock

DOOR HANDLES



UNO door handle - stainless steel



backplate for simple key



backplate for cylinder lock



backplate for toilet lock



ROMANA door handle - chrome/varnished nickel



backplate for simple key



backplate for cylinder lock



backplate for toilet lock



TIK-QR door handle - anthracite



backplate for simple key



backplate for cylinder lock



backplate for toilet lock



QUBIK door handle - varnished nickel



backplate for simple key



backplate for cylinder lock



backplate for toilet lock



LIBRA door handle - satin nickel



backplate for simple key



backplate for cylinder lock



backplate for toilet lock

Note: long backplates do not fit doors with magnetic lock



ZORBA door handle with long backplate
long backplate - glossy chrome /



ZORBA door handle with long backplate - glossy chrome/satin
(spacing 72 mm)



ZORBA door handle with long backplate
for cylinder lock - shiny chrome/
satin (span 72 mm)



ZORBA door handle with long backplate
long toilet backplate - glossy chrome
/ satin (spacing 72 mm)



SHARK door handle black and inox



SHARK backplate black and inox

SHARK door handle for the SOLID / ENTER



DIVA door handle and backplate
for door leaves FORCA 10 and FORCA B
10 silver F1
door handle
long backplate

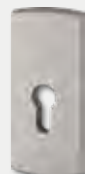

ONTARIO door handle and backplate
for SOLID RC2 model
silver colour F1
door handle
long backplate



DOOR HANDLES



STAR TEC technical handle - class IV - stainless steel matt price for a set (handle + backplate for cylinder lock)



backplate for cylinder lock

door leaf thickness up to 55 mm



PEGAZ door handle (span 72 mm)
Nickel mat for cylinder lock



TOM door handle with long backplate
for cylinder lock (span 72 mm) matt chrome

exterior backplate

interior backplate

NOTE:
selection of left or right door handle*.
Door handle in set with backplate is
adapted to door leaf with two locks except
SOLID collection.



METRO door handle (72 mm span)
stainless steel for cylinder lock

METRO upper backplate
stainless steel for cylinder lock

*left door handle

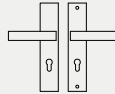

*right door handle



exterior TOTAL door handle with long
backplate (72 mm span)
inox plus -

NOTE:
Door handle in set with backplate is
adapted to door leaf SOLID with two locks.



TOTAL upper backplate
short inox plus

Note: long backplates do not fit doors with magnetic lock

CYLINDER LOCK INSERTS

SELF-CLOSER



cylinder lock insert 26/41
- nickel matt



cylinder lock insert 26/41
- brass satin



set of cylinder lock inserts ZN
30/40+30G/40 SN
or ZN 30/40+40G/30 SN nickel satin

system
single key system



set of cylinder lock inserts ZN
30/40+30G/40 SB
or ZN 30/40+40G/30 SB brass satin



DORMA TS-90 impuls selfcloser



DORMA TS-71 selfcloser
.....



GEZE TS 2000 selfcloser

DECORS



white (wood grain structure)	white matt	white pine	siberian elm	silver	sand oak
bleached oak textured	vintage oak	tabac elm	marrone chestnut textured	evoke oak	toffee oak ***
anthracite elm	golden oak textured	walnut	dark walnut textured	caramel walnut	gray textured
black matt 2	gray oak textured ***	dark wenge	black textured	antique copper	oxide concrete
light gray matt	dark olive matt	dark blue matt		riviera oak	rustic oak

*** decors only in horizontal graining, *decor available while stocks last



american walnut	ebony*	elm	Polish oak 3D	grand oak
--------------------	--------	-----	---------------	-----------



white UV acrylic lacquer RAL=9003	ecru RAL=9001	latte Flugger = 4362 NCS = S1505-Y50R	ashen RAL=7035
---	------------------	---	-------------------



LUX collection decors

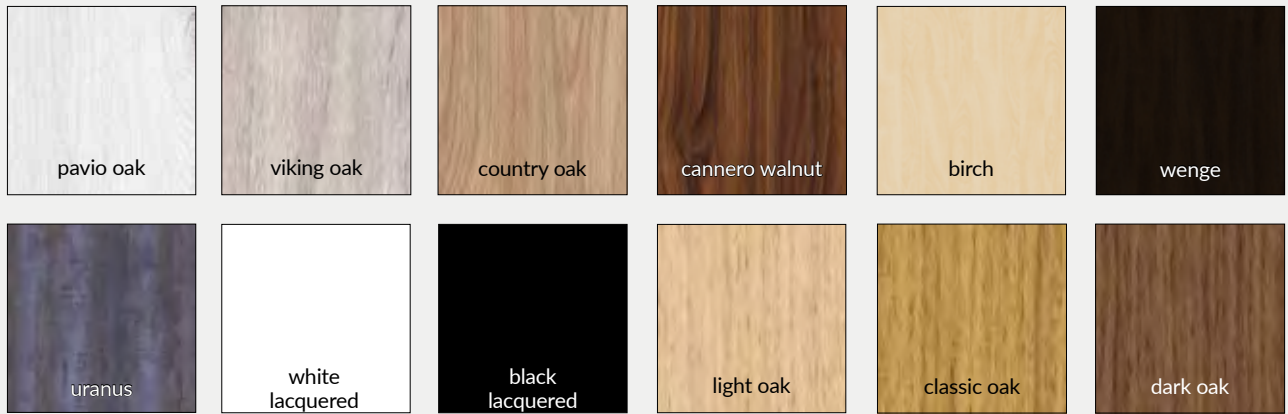

Decors from CLARO and GRAFI collections,

WOOD collection decors

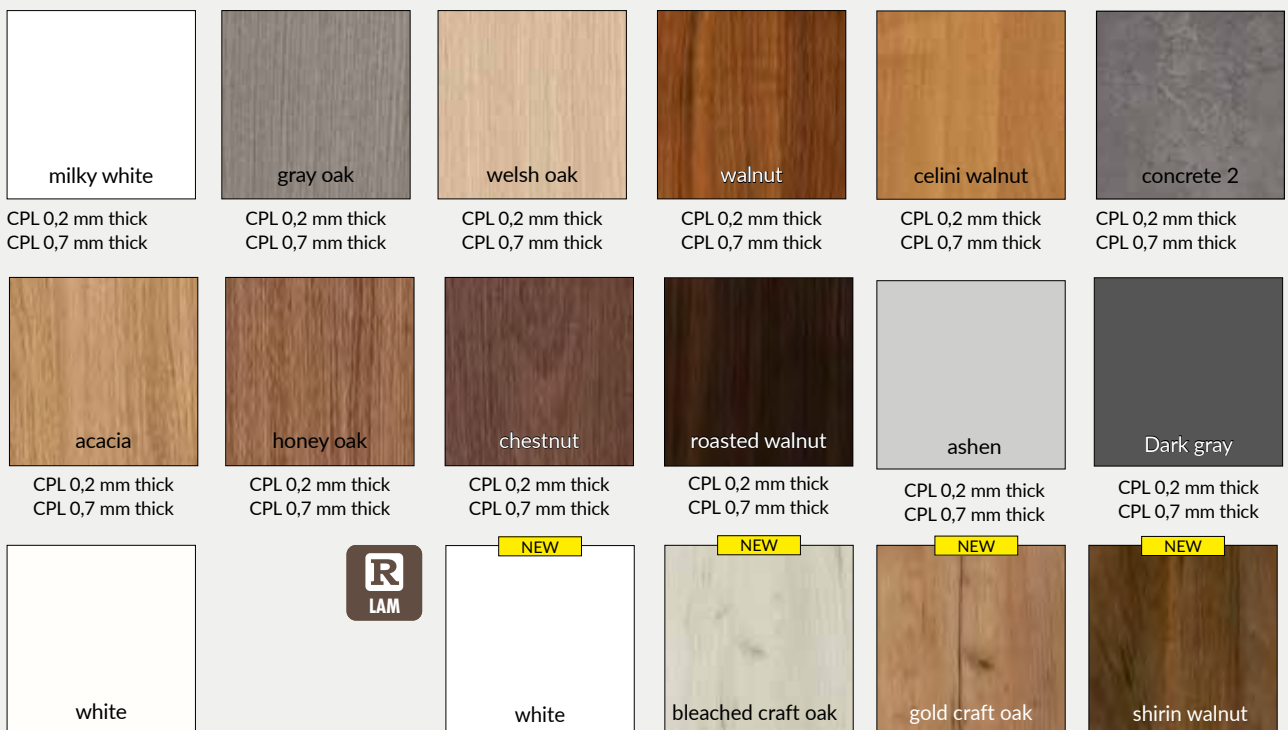

W0118
CPL 0,15 mm thick
CPL 0,7 mm thick

DRE-PRINT collection G

NON-REBATED DOOR LEAF
interior door leaf



Scaling of the patterns in G1 - G6 graphics in the selected door leaves widths with right opening

G1 graphic pattern



"60"

G2 graphic pattern



"60"

G3 graphic pattern



"60"

G4 graphic pattern



"60"

G5 graphic pattern



"60"

G6 graphic pattern



"60"



"70"



"70"



"70"

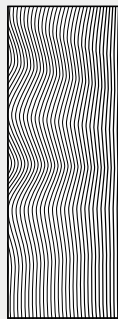

"70"

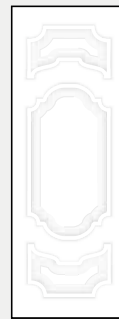

"70"



"70"



"90"



"90"

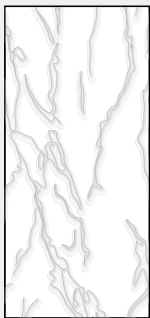

"90"

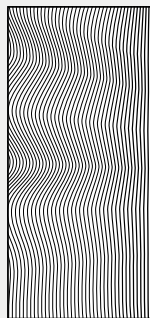

"90"

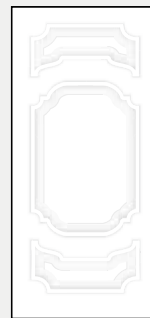

"90"



"90"



"100"



"100"

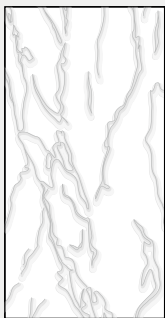

"100"

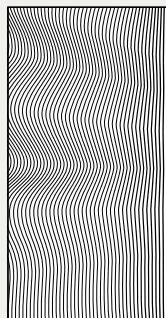

"100"

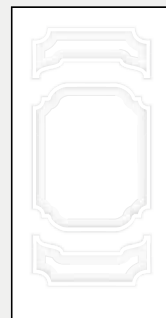

"100"

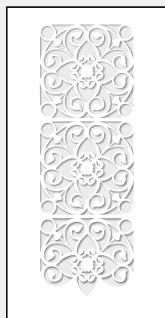

"100"

Scaling of graphics patterns in the width of the door leaf "80" is presented on page 54 and 55

Scaling of the patterns in G7 - G12 graphics in the selected door leaves widths with right opening

G7 graphic pattern	G8 graphic pattern	G9 graphic pattern	G10 graphic pattern	G11 graphic pattern	G12 graphic pattern
"60"	"60"	"60"	"60"	"60"	"60"
"70"	"70"	"70"	"70"	"70"	"70"
"90"	"90"	"90"	"90"	"90"	"90"
"100"	"100"	"100"	"100"	"100"	"100"

Scaling of graphics patterns in the width of the door leaf "80" is presented on page 54 and 55

DRE-PRINT collection G

NON-REBATED DOOR LEAF
interior door leaf



Scaling of the patterns in G13 - G18 graphics in the selected door leaves widths with right opening

G13 graphic pattern

G14 graphic pattern

G15 graphic pattern

G16 graphic pattern

G17* graphic pattern

G18* graphic pattern



"60"



"60"



"60"



"60"



"60"



"60"



"70"



"70"



"70"



"70"



"70"



"70"



"90"



"90"



"90"



"90"



"90"



"90"

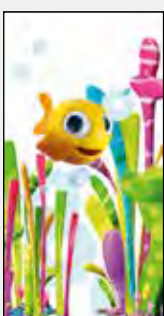

"100"



"100"

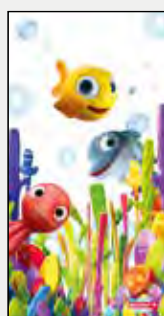

"100"



"100"



"100"



"100"

Scaling of graphics patterns in the width of the door leaf "80" is presented on page 54 and 55
* pattern versions available for the right and left door leaf

Scaling of the patterns in G19 - G25 graphics in the selected door leaves widths with right opening

G19 graphic pattern G20* graphic pattern G21 graphic pattern G22 graphic pattern G23 graphic pattern G24* graphic pattern G25 graphic pattern



"60"



"60"



"60"



"60"

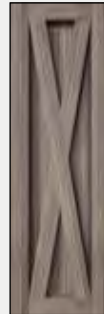

"60"

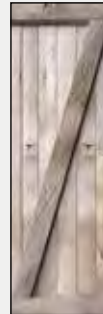

"60"

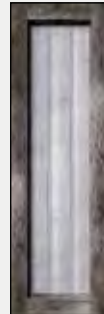

"60"



"70"



"70"



"70"



"70"

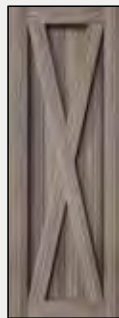

"70"

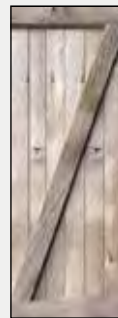

"70"



"70"



"90"



"90"



"90"



"90"



"90"

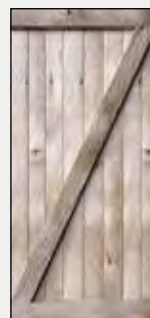

"90"



"90"



"100"



"100"



"100"



"100"



"100"



"100"



"100"

Scaling of graphics patterns in the width of the door leaf "80" is presented on page 54 and 55
* pattern versions available for the right and left door leaf

GLASS PANE PATTERNS



pattern 1 VETRO
transparent



pattern 1 VETRO
decormat



pattern 1 VETRO
decormat brown



pattern 1 VETRO
decormat graphite



pattern VETRO E, VETRO D1
black opaque laminated glass

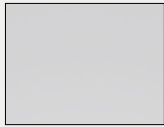

VETRO pattern E
laminated glass
decormat



pattern 2 VETRO



pattern 3 VETRO



pattern 4 VETRO



pattern 5 VETRO



pattern 10 VETRO



pattern 11 VETRO



pattern 12 VETRO



pattern 13 VETRO



pattern 14 VETRO



pattern 15 VETRO

GLASS PANE PATTERNS

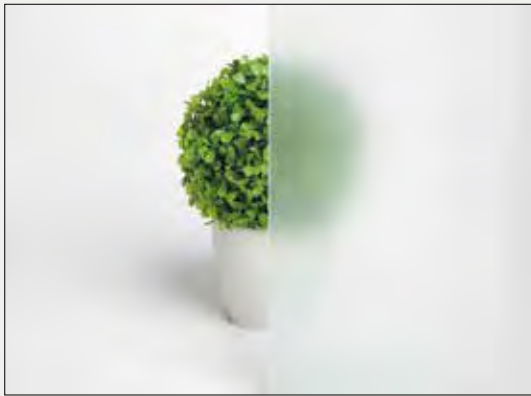

MAT DRE

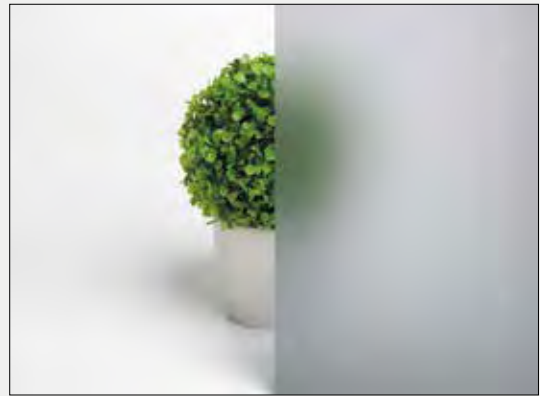

decormat graphite

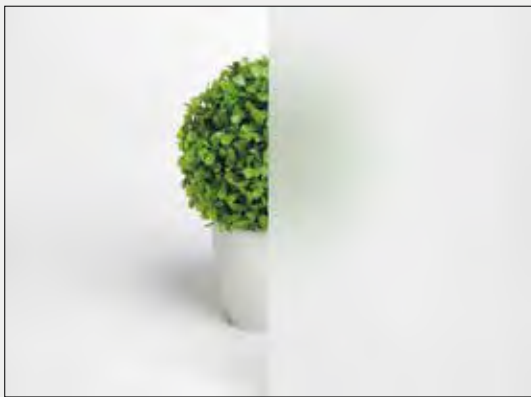

white frost laminated VSG 22,1, plain on both sides

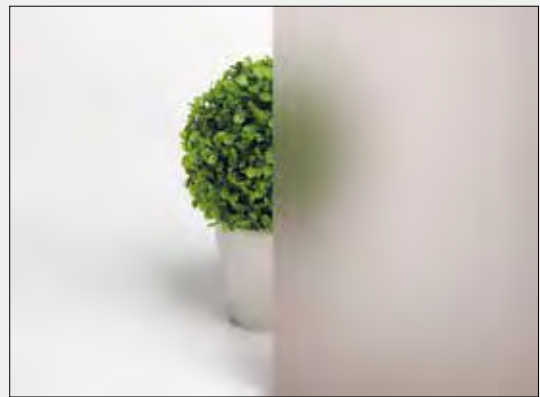

decormat brown



window blind



chinchila



white bark

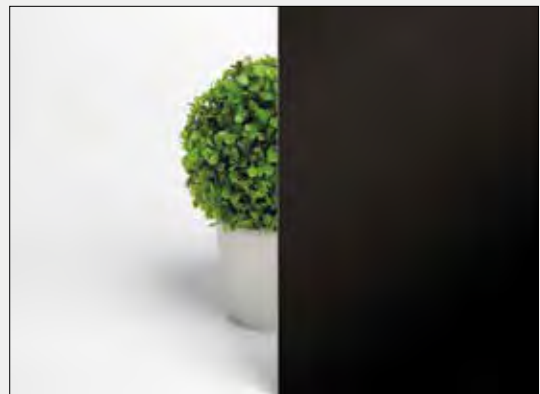

VSG black

PRICES

Prices and availability of glass panes are presented on pages with door leaves. The glass in the door leaves of our collections have obverse and reverse (except VSG 22,1 and VETRO E, VETRO D1).

ARCHITRAVES AND SKIRTING BOARDS

MASKING ARCHITRAVE

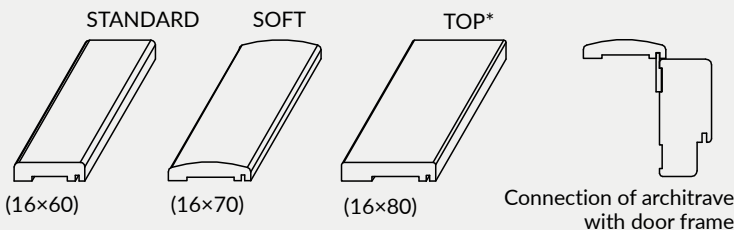

application: fixed door frame, fixed door frame SOFT

Set contains (for one side of the door):

one horizontal and two vertical components, pins and clips. Architrave are packed in a cardboard boxes.

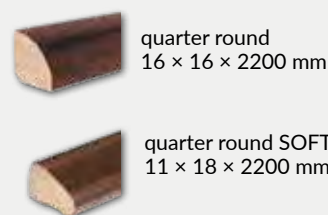

QUARTER ROUNDS

Quarter round are used to mask the angular connection between the wall and the door frame.

A single item constitutes a trade unit.

SKIRTING BOARDS



The length of the skirting boards is 2,62 m (except LPP4W). Skirting boards need to be trimmed prior to installation.

* only Cell and 3D decors

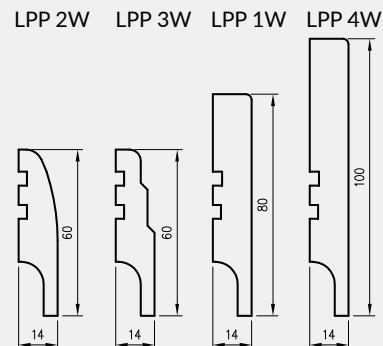

Length of LPP4W skirting board is 2,40 linear meter

It is made of moisture resistant board.

VENTILATION GRILLE

There is possibility to instal bathroom plastic ventilation grille, which is available in the following colours: white, beige, calvados, brown, silver, creamy, gray, black and ashen (except for frame construction doors, sliding doors, fire resistant doors and SOLID, ENTER) or aluminum ventilation grille

- » plastic ventilation grille
- » aluminum ventilation grille



plastic ventilation grille



aluminum ventilation grille

VENTILATION ACCESSORIES AND OTHER

VENTILATION SLEEVES FOR PANEL DOORS

There is possibility to purchase a set (5 pcs) of ventilation sleeves.
DRE-Cell Decor, 3D foil, CPL laminate.

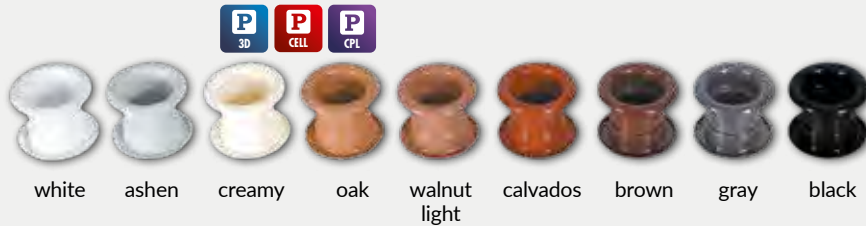

VENTILATION SLEEVES FOR FRAME CONSTRUCTION DOOR LEAF

For frame construction doors, except for VETRO with plastic sleeves (3 sleeves for doors "60", 4 sleeves for doors "70", 5 sleeves for doors "80"- "100")

PLASTIC VENTILATION SLEEVES

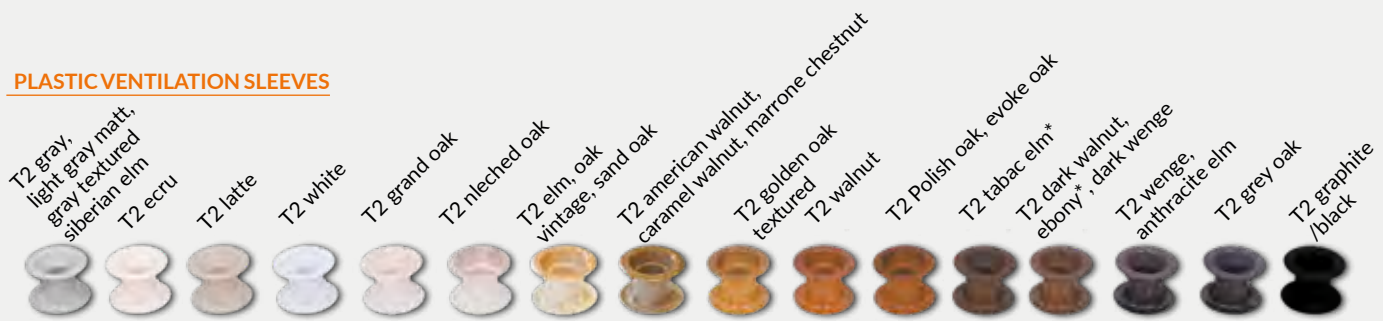

VENTILATION UNDERCUT

In all collections (except SOLID, SOLID RC2, ENTER, FIRE resistant door leaves, sliding doors, folding), ventilation undercut can be made upon request.

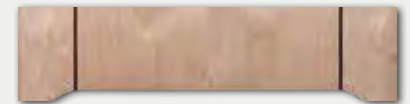

ventilation undercut

HINGE COVERS

» (set consist of 2 pcs. for 1 hinge)

Plastic hinge covers are adjusted to hinges with diameter of 13,5 mm.

» thimble (price for 1 pcs.)

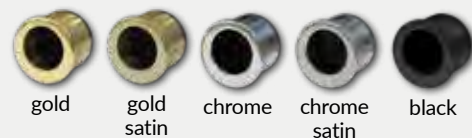

TECHNICAL INFORMATIONS

DOOR LEAF DIMENSION AND PLACEMENT OF HINGES

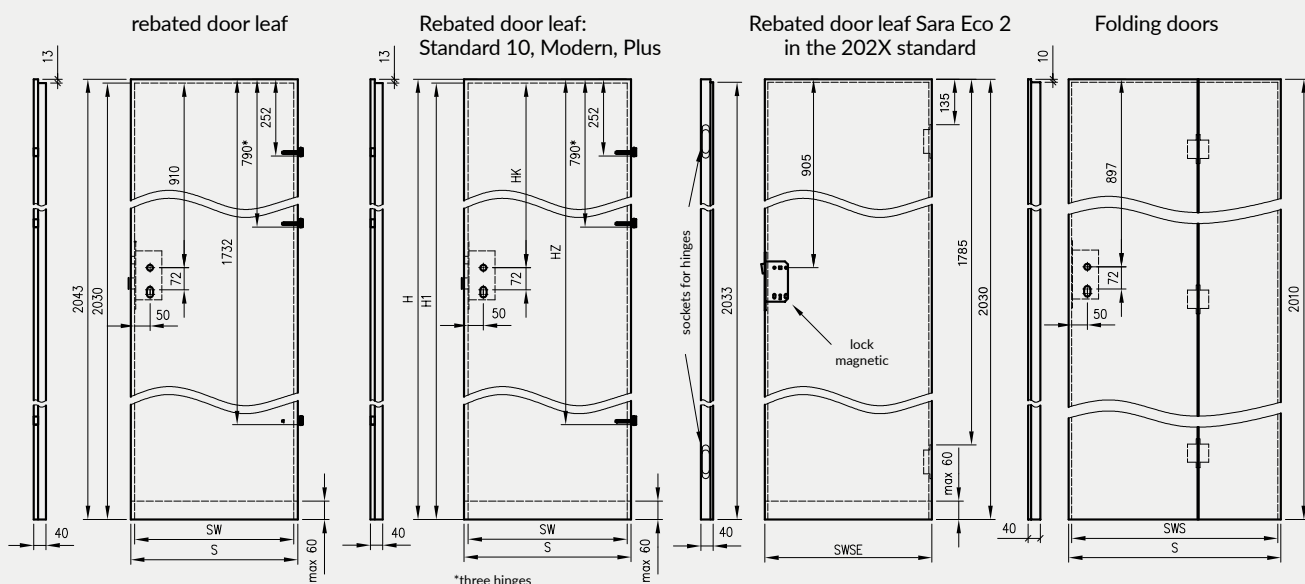

*three hinges

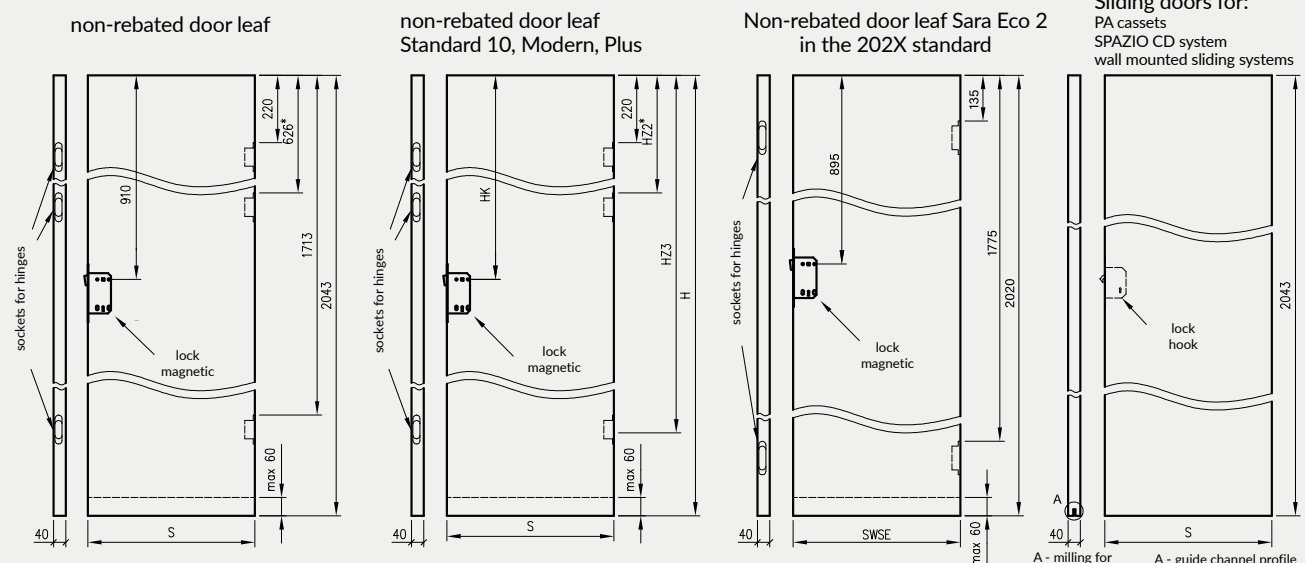

* in case

Note: magnetic locks in two variants of spacing: 85mm for a cylinder lock insert or 90mm for a simple key and toilet lock insert

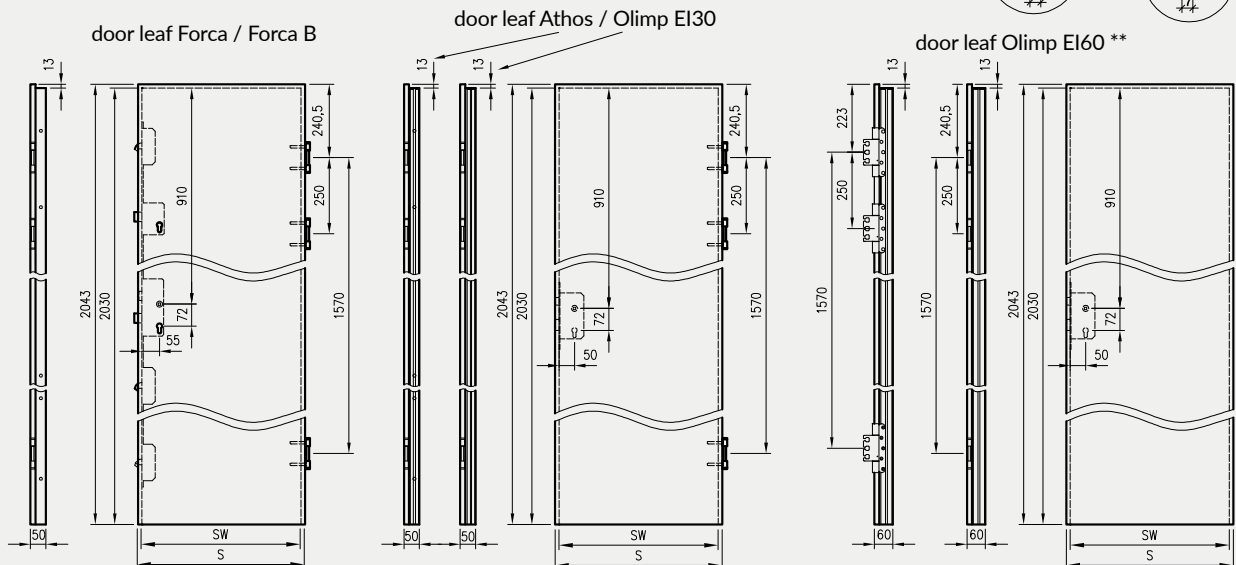

** Olimp EI60 two options of hinges (depending on the width of the door)

TECHNICAL INFORMATIONS

DOOR LEAF WIDTH

Symbol of the door dimension	S	SW	SWSE	SWS
"60"	644	618	620	-
"70"	744	718	720	-
"80"	844	818	820	824
"90"	944	918	920	924
"100"	1044	1018	1020	1024
"110*"	1144	1118	-	-

S - total door leaf width
 SW - width in the rebate (refers to rebated door leaf)
 SWSE - Sara Eco 2 leaf width
 SWS - width in the rebate of folding door leaf
 * - width "110" is only available in door leaves Standard 10, Athos, Enter Acoustic and Olimp

NOTE: Total width of "40" side panels is 444 mm.

ADDITIONAL LEAF WIDTHS

Symbol of the door dimension	S	SW
"90E" for OLIMP EI30, ATHOS, FORCA, FORCA B.	959	933
"90E" for OLIMP EI60	969	943
"90E" for STANDARD, ENTER, ENTER AKUSTIK, SOLID, SOLID RC2	948	922

The investment standard "90E" provides 900mm passage in the door frame with the door leaf opened at an angle of 90 degrees

DIMENSIONS OF THE DOOR LEAF WITH 4 VARIABLE HEIGHTS

(refers to door leaf STANDARD 10 and collections MODERN and PLUS)

H	H1	HK	HZ	HZ2	HZ3
1983	1970	850	1672	606	1653
2043	2030	910	1732	626	1713
2110	2097	977	1799	647	1780
2240	2227	1107	1929	691	1910

H - total height of the door leaf
 H1 - door leaf height in the rebate
 HK - distance from the top rebate of door leaf to the axis of the handle
 HZ - distance from the upper edge of the door leaf to the mounting point of the third hinge

DOOR LEAF HEIGHT

2043 mm - total height of rebated and non-rebated door leaf (2010 for folding doors)
 2030 mm - total height of door leaf in rebate (2020 for Sara Eco 2 rebated door leaf, 2000 for folding doors)
 2055 mm - total height of the door leaves with inverted rebate
 1983, 2043, 2110, 2240 mm - total possible height of STANDARD 10 door leaf and MODERN and PLUS collection (1970, 2030, 2097, 2227 mm - measured in the door leaf rebate)

SHORTENING OF DOOR LEAF

There is possibility to shorten door leaf by your own, up to 60 mm (there is no possibility to shorten following door leaf: VETRO, FIRE RESISTANT DOORS, FORCA B, door leaf of all collections in the sliding version, passive doors, glass doors, folding doors and door leaves with dropping seal).

CLEARANCE BETWEEN DOOR LEAF AND FLOOR

standard clearance between door leaf and finished floor is 8 mm high (15 mm in FOLDE door leaf, 5-6 mm in OLIMP door leaf).

NOTES REFERED TO HINGE

In rebated door leaf: frame construction doors, entrance (Enter, Enter Acoustic, Solid) and in the other collections with size wider than "90", 3 screw-in pivot hinges of $\varnothing 13,5$ mm are mounted. For other interior rebated leaves, there is possibility to choose 2 or 3 hinges.
 In SOLID RC2, FORCA, FORCA B, ATHOS and OLIMP EI30 door leaf there are mounted 3 threefold hinges.
 The OLIMP EI60 leaves, depending on the width, are equipped with 3 three-part hinges or 3 SIMONSWERK hinges VX 7939/160.
 Non-rebated door leaf come with pre-milled sockets for two or three hidden recessed hinges which are attached together with non-rebated door frame.
 Sara Eco 2 rebated and non-rebated door leaf come with pre-milled sockets for recessed hinges that are attached together with the door frame.
 Folding doors come with 3 hidden recessed hinges which join two parts of door leaf.
 Door leaves with inverted rebate have sockets for two recessed hinges, which are packed together with door frame.

Non-rebated door leaf



REBATED DOOR LEAF

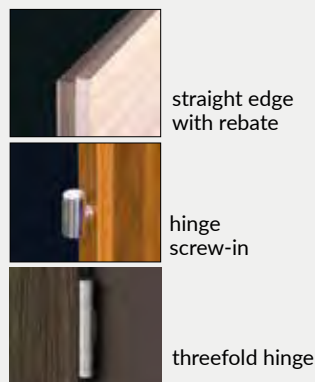

TECHNICAL INFORMATIONS

DOOR LEAF THICKNESS AND SELECTION OF CYLINDER INSERT

Door leaf type	Door leaf thickness	proportion in the door leaf (W0/Z0)	recommended** dimension of the cylinder insert (W/Z)	Refers to cylinder insert with door knob	
				Cylinder insert with a door knob inside (W/Z)	Cylinder insert with a door knob outside (W/Z)
rebated door leaf	40	14 / 26	25 / 40 26 / 36 26 / 41 30 / 40	25G / 40 26G / 36 26G / 41 30G / 40	25 / 40G 26 / 36G 26 / 41G 30 / 40G
Rebated door leaf Sara Eco 2	40	24 / 16	35 / 30 36 / 26 36 / 31 40 / 30	35G / 30 36G / 26 36G / 31 40G / 30	35 / 30G 36 / 26G 36 / 31G 40 / 30G
Non-rebated door leaf	40	20 / 20	31 / 31 30 / 30 35 / 35	31G / 31 30G / 30 35G / 35	
Non-rebated door leaf Sara Eco 2	40	16 / 24	30 / 35 26 / 36 31 / 36 30 / 40	30G / 35 26G / 36 31G / 36 30G / 40	30 / 35G 26 / 36G 31 / 36G 30 / 40G
Door leaf with inverted rebate	40	27 / 13	40 / 25 41 / 26	40G / 25 41G / 26	40 / 25G 41 / 26G
Folding doors	40	17/23	30/35 31/36 30/40	30G / 35 31G / 36 30G / 40	30 / 35G 31 / 36G 30 / 40G
fire resistance Athos	50	21 / 29	31 / 41 35 / 40	31G / 41 35G / 40	31 / 41G 35 / 40G
Olimp EI30	50	18 / 32	30 / 45 31 / 46	30G / 45 31G / 46	30 / 45G 31 / 46G
Olimp EI60	60	28 / 32	40 / 45 41 / 46	40G / 45 41G / 46	40 / 45G 41 / 46G
fire resistance FORCA	50	22 / 28	35 / 40		
SOLID RC2	40,6	14 / 26,6	26 / 40 26 / 41 30 / 40		

Cylinder inserts are reversible - that is 25/40 = 40/25, 26G/36 = 36/26G

**recommended dimensions (assuming that backplate is 10 mm thick, and cylinder insert doesn't exceed 5 mm above backplate).

fig. selection of cylinder insert dimension

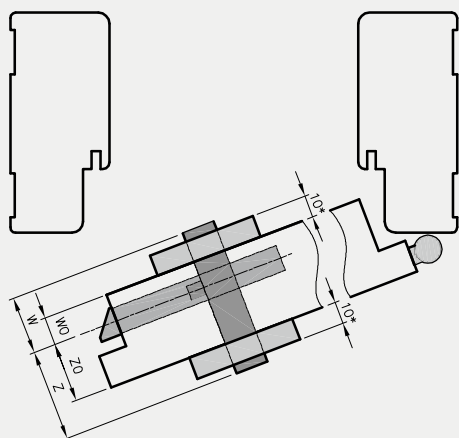
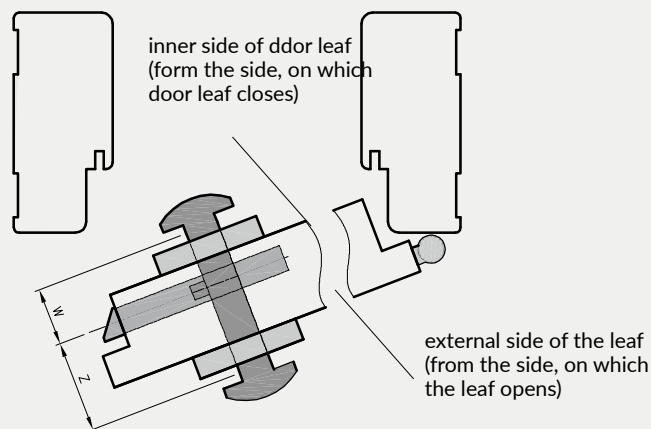

fig. selection of cylinder insert dimension with door knob



Dimension of cylinder insert is calculated using the following formula:

$W0 + \text{backplate thickness} + 2 \div 3\text{mm} / Z0 + \text{backplate thickness} + 2 \div 3\text{mm}$ where:

W0 and Z0 - values have been presented in the table above
thickness of the backplate - measured (presented values in above table assume that backplate is 10mm thick)

Selection of backplate with door knob - if we want to mount a knob on:

- the inner side of door leaf - symbol of the door knob must be next to "W" dimension (see column 5 in the table)

- the external side of the leaf - symbol of the door knob must be next to "Z" dimension (see column 6 in the table)

TECHNICAL INFORMATIONS

SINGLE LEAF REBATED DOOR

We offer left, right and central door leaf

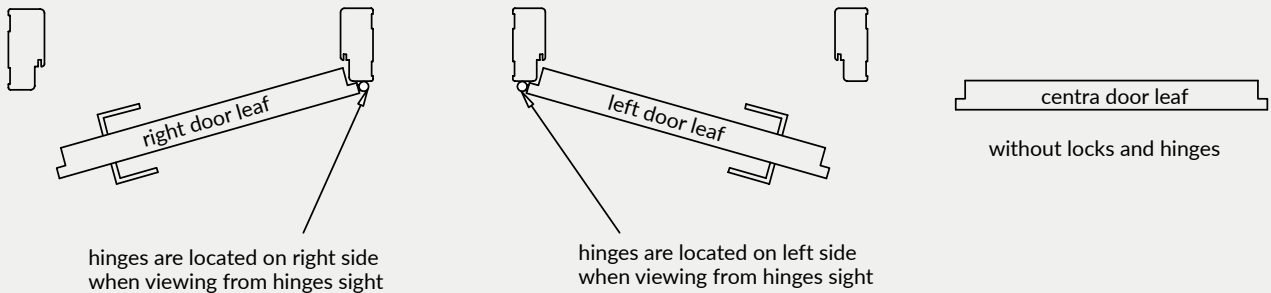

DOUBLE LEAF REBATED DOOR

We offer double leaf doors: the right - then right door leaf becomes an active one and left door leaf becomes inactive, and double left leaf - left leaf is an active one and the right one is inactive.

An active door leaf has a rebate and a lock as a standard option. In double leaf door there is available only straight edge.

Inactive door leaf comes with a "counter rebate" and additionally is equipped with a latch strike plate and a flush bolt as a standard fitting (A)

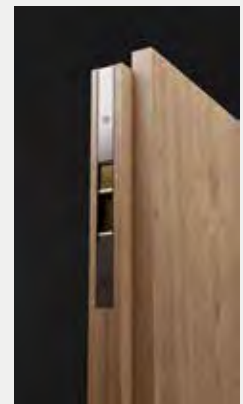

flush bolt (A)

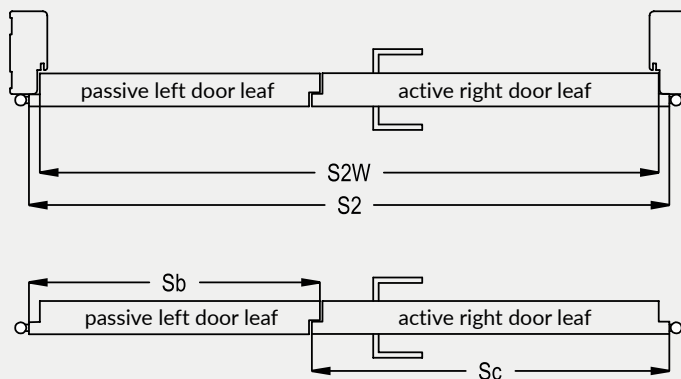

Only door frames produced by DRE fit double-leaf doors, that is the reason that we recommend to our customers to buy doors as a complementary sets. Whole DRE set comprises of 2 door leaf and door frame.

$$\boxed{\text{price of double leaf door}} = \boxed{\text{leaf price} \times 2} + \boxed{\text{price of the fire resistance}}$$

Symbol of door dimension	dimension in [mm]		
	S2	S2W	combination* Sc+Sb
"100d"	1078	1052	644+444
"110d"	1178	1152	744+444
"120"	1278	1252	844+444; 644+644
"130"	1378	1352	944+444; 744+644; 644+744
"140"	1478	1452	1044+444; 844+644; 744+744; 644+844
"150"	1578	1552	944+644; 844+744; 744+844; 644+944
"160"	1678	1652	1044+644; 944+744; 844+844; 744+944; 644+1044
"170"	1778	1752	1044+744; 944+844; 844+944; 744+1044
"180"	1878	1852	1044+844; 944+944; 844+1044
"190"	1978	1952	1044+944; 944+1044
"200"	2078	2052	1044+1044

combination* possible combination of active (Sc) and inactive (Sb) leaf width

TECHNICAL INFORMATIONS

NON-REBATED DOOR LEAF - SLIDING VERSION

We offer left, right and central door leaf (door leaf without a lock and handle)

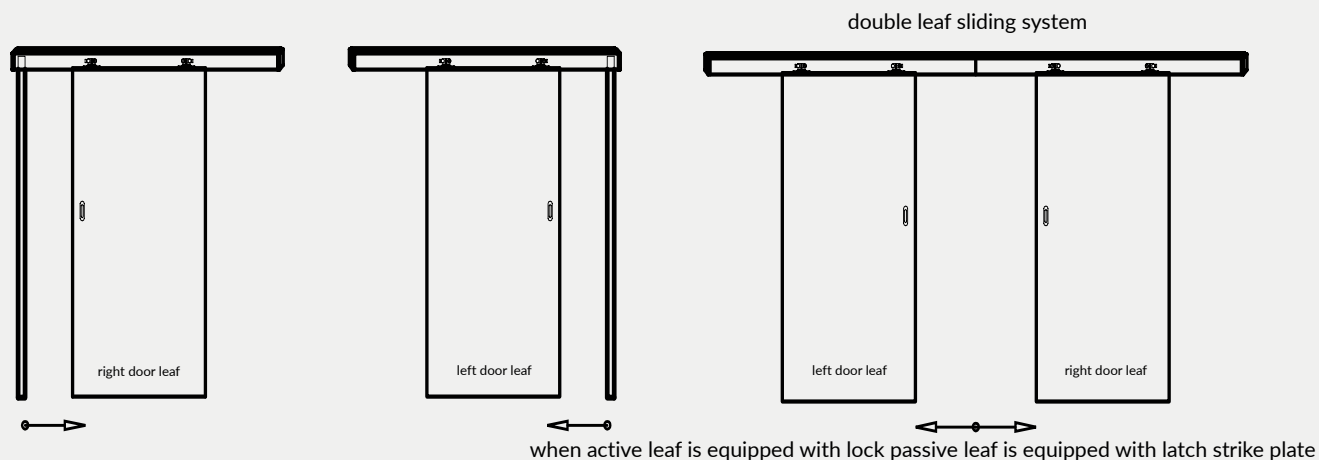

SINGLE LEAF DOOR NON-REBATED

We offer left, right and central door leaf

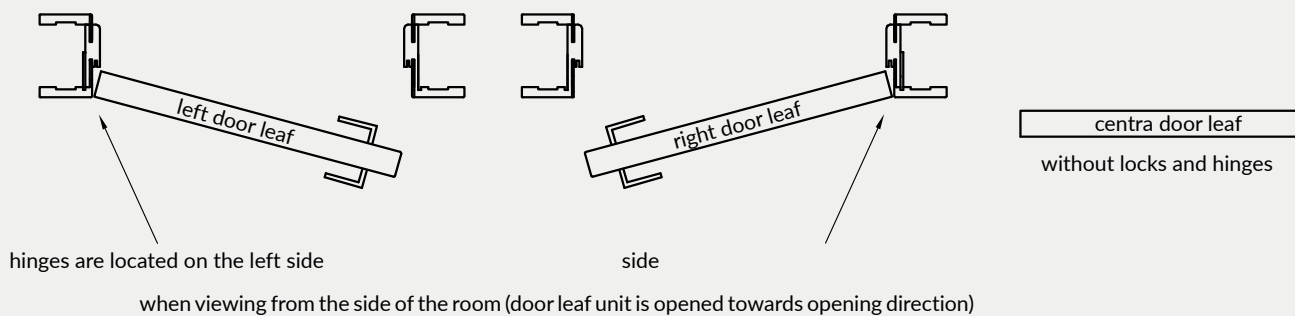

DOUBLE LEAF NON-REBATED DOOR

We offer double leaf doors: the right - then right door leaf becomes an active one and left door leaf becomes passive, and double left leaf - left leaf is an active one and the right one is passive.

An active door leaf has lock as a standard option. Passive door leaf is equipped with a latch strike plate and a flush bolt as a standard fitting.

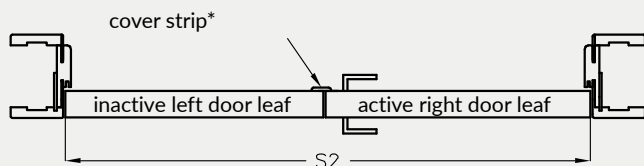

* for double leaf non-rebated doors there is possibility to purchase cover stripe width of cover stripe 30 mm

$$\boxed{\text{price of double leaf door}} = \boxed{\text{leaf price} \times 2} + \boxed{\text{price of the fire resistance}}$$

Symbol of door dimension	dimension in [mm]	
	S2	combination* Sc+Sb
"120"	1291	644+644
"130"	1391	744+644; 644+744
"140"	1491	844+644; 744+744; 644+844
"150"	1591	944+644; 844+744; 744+844; 644+944
"160"	1691	1044+644; 944+744; 844+844; 744+944; 644+1044
"170"	1791	1044+744; 944+844; 844+944; 744+1044
"180"	1891	1044+844; 944+944; 844+1044

combination* - possible combination of active (Sc) and inactive (Sb) leaf width

TECHNICAL INFORMATIONS

CONSTRUCTION OF PANEL DOORS

- » door leaf frame made of coniferous wood or MDF
- » Core: stabilizing insert "honeycomb" (A), perforated chipboard (B) and in fire proof doors: chipboard
- » External 3mm HDF board or external HDF 4mm board (in Finea, Finea B, Enter, Enter Acoustic, Solid)
- » type of edge straight or without rebate

External boards of door leaf is finished with:

- a) in DRE-Cell decor collection - decorative foil based on the polypropylene
- b) in 3D foil - 3D foil based on decorative paper
- c) in CPL laminate - CPL laminate th. 0,15-0,2 mm or 0,7 mm

Fire resistant door leaf Olimp EI30

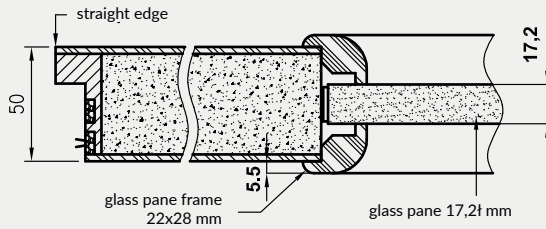

Fire resistant door leaf Olimp EI60

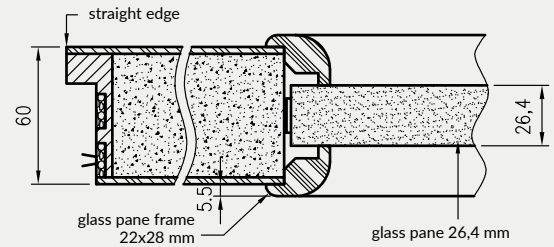

Anti-burglary door and fire-resistant door leaf Forca EI30

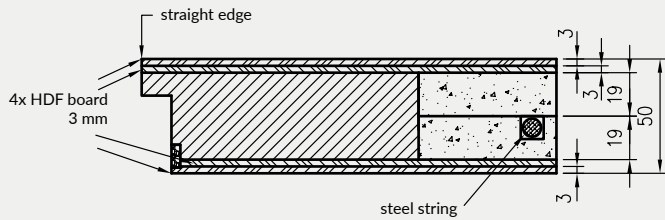

Anti-burglary door leaf Forca B

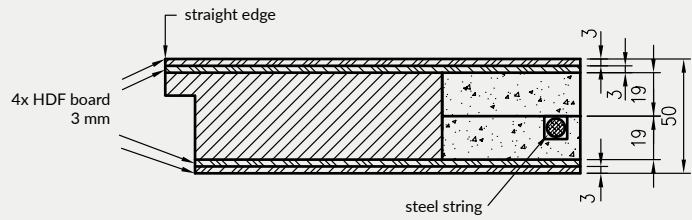

Anti-burglary door leaf SOLID RC2

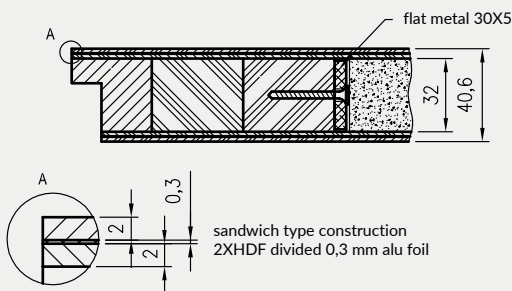

Fire-resistant door leaf Forca EI30

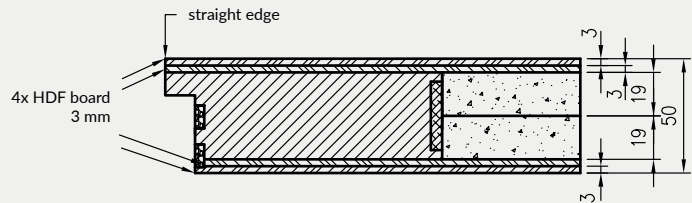

(A) stabilising insert "honeycomb"



(B) perforated chipboard

TECHNICAL INFORMATIONS

FRAME CONSTRUCTION DOORS (IS NOT REFERRED TO VETRO A,B,C,D,F)

Frame construction door leaf is entirely made of wood-based panels:

vertical stiles made of wood-based panels - 40 mm

external horizontal stiles made of wood-based panels - 35 mm

horizontal rails (interior):

- wood-based panels - 22 mm in Auri, Piano, Even, Premium, Fosca, Verso, Reva, Solte, Trieste*, Ena*, Verano* door leaves (* In Ena 1-2, Trieste 1-2, 1-2 and Verano 1-2 collections, a rail and stile set by the large glass pane made of wood-based panels - 35 mm. In Ena 3-5, Verano 3-5, 3-5 and Triesta 3 models, two rails by the large glass panes made of wood-based panels - 35 mm.)

- wood-based panels - 35 mm in Nestor, Elsa, Scala, Berge, Estra door leaves.

Horizontal cross-section of door leaf
Auri, Verano, Piano, Premium, Fosca, Verso, Ena,
Even, Trieste, Reva, Solte

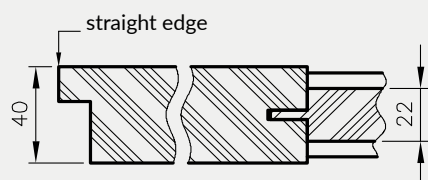

Horizontal cross-section of ELSA

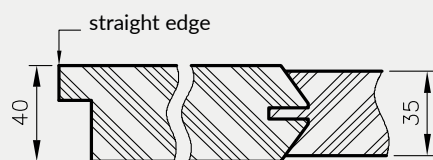

Horizontal cross-section of Ena, Verano and
Trieste doors (cross-section at the height of
the rail and stile set by the large glass pane)

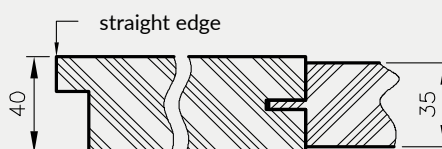

Horizontal cross-section of Nestor

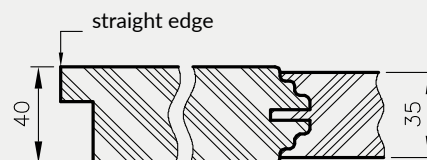

Horizontal cross section of the door leaf Scala, Berge

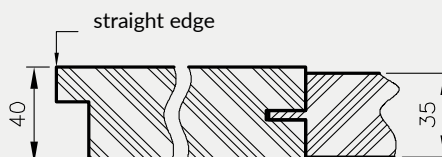

FILLINGS OF FRAME CONSTRUCTION DOOR LEAF:

Scala A; - 4 mm glass pane, flat 4 mm HDF board

Scala B - 4 mm glass pane, 19 mm MDF profiled board

Elsa A - 4 mm glass pane, flat 4 mm HDF board

Elsa B - 4 mm glass pane, 19 mm MDF profiled board

Premium 1-3 - 4 mm glass pane

Premium 4-7, 12 - 4 mm glass pane, 4 mm HDF marquetry made in door leaf colour

Premium 8-11, 13 - 4 mm glass pane, 4 mm HDF marquetry coated with silver laminate

Piano 1-6 - 4 mm glass pane, 16 mm MDF profiled board

Piano 9-12 - 4 mm glass pane, 19 mm MDF profiled board

Fosca 1-3 - 4 mm glass pane, 4 mm HDF board coated with silver laminate

Fosca 4-6 - 4 mm HDF board coated with veneer in door leaf colour

Nestor, Berge - 4 mm glass, 19 mm profiled MDF panel

Ena, Trieste, Auri, Verano, Even, Reva, Solte, Verso - 4 mm glass pane

Estra - 4 mm glass, 16 mm flat MDF panel, undercut

profile of 19 mm MDF board
(Scala B, Piano 9-12, Elsa B,
Nestor, Berge)

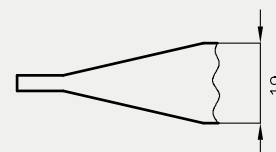

profile of 16 mm MDF
(Piano 1, 2, 5, 6)

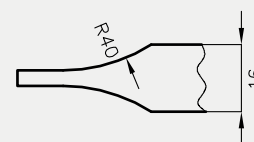

KICK PLATES

Kick plates so called „OKOPNIKI” it is finishing solution for selected panel door models with straight edge. We offer door leaf covered with thin 0,6 mm metal sheets made of stainless steel optional bottom and middle panels. It is also possible that both of panels are installed at the same time on the selected door leaf. Height of the panel is 300 mm. Door leaf with kick plates must be filled with perforated chipboard.



door leaf model with bottom panel

door leaf model with middle panel

door leaf model with bottom and middle panel

There is possibility to order door leaf with bottom panel and ventilation undercut.

NOTE: If you wish to place an order, please contact the Customer Service Department.

REMAINING TECHNICAL INFORMATIONS:

- While maintaining standard dimensions of door leaf and door frame, clearance between "finished" floor and bottom edge of the door leaf is 8 mm. In order to reduce clearance, door frame should be appropriately shortened at the bottom (it doesn't refer to FOLDE and OLIMP)
- Note! Prior to the purchase and assembly of construction woodworking, check whether the selected type of joinery meet technical requirements of the project and technical drawings, it is particularly necessary to make sure that the construction of walls and ceilings allows for the mounting of construction woodworking of weight specified in the table below:

	door leaf			Door frames		other products	
	interior	entrance	fire-resistance	adjustable	fixed	Adjustable tunnel	Sliding system
Max weight	50 kg*	50 kg*	105 kg*	40 kg	20 kg	40 kg	20 kg

* max weight of single leaf door

- Door leaf is wrapped in shrink film and the edges are additionally protected with Styrofoam or cardboard inserts.
- Price of door leaf does not include door handles, backplates and cylinder inserts (with the exception of SCALA A and B collections in rebated and non-rebated versions in DRE-Cell veneer and 3D veneer also excluding NESTOR and ELSA collections in rebated and non-rebated version in DRE-Cell veneer and 3D veneer, where handle and backplate come 1).
- It is possible to purchase doors and door frames CENTRA (in this option there is no sockets for the lock and hinges - option is not available for fire doors, ENTER/SOLID, ENTER ACOUSTIC, SOLID RC2, FORCA B, Sara Eco 2, FOLDE) at a price of a similar product equipped with hardware and pre-milled sockets. CENTRA door frames come with door seal. Set does not include hardware.

CROSS-SECTIONS OF ALUMINUM FRAMES

DRE profile for non-rebated outward opening doors

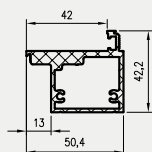

DRE profile for rebated inward opening doors

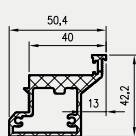

Profile for non-rebated outward opening doors

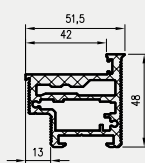

Profile for rebated doors opening inwards

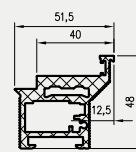

TECHNICAL INFORMATIONS

Under the current regulations, doors to the bathroom, wash room and a separate toilets must be opened to the outdoors have width of at least 0,8 meter and height of 2 meter and also have on the bottom part openings with their total surface not smaller than 0,022 m², in order to fulfill correct air circulation. Door ventilation surface is the sum of the available ventilation components: ventilation grille (ensures the ventilation surface of 0,022 m² in all widths of doors) or ventilation undercut or ventilation sleeves, and the surface of the ground clearance between door leaf and the floor.

Ensuring ventilation surface for rebated doors**

Symbol of door leaf dimension	doors with ventilation sleeves		doors with ventilation undercut	
	ventilation surface of sleeves and the clearance 8 mm [m ²]	required clearance to meet ventilation requirements [in mm]	ventilation surface of the undercut and the clearance 8 mm [m ²]	required clearance to meet ventilation requirements [in mm]
"100"	0,011	19*	0,033	0
"90"	0,010	21*	0,029	1
"80"	0,009	24*	0,025	4
"70"	0,008	28*	0,021	14*
"60"	0,007	33*	0,018	35*

Ensuring ventilation surface for Sara Eco 2 doors and all non-rebated doors

Symbol of door leaf dimension	doors with ventilation sleeves		doors with ventilation undercut	
	ventilation surface of sleeves and the clearance 8 mm [m ²]	required clearance to meet ventilation requirements [in mm]	ventilation surface of the undercut and the clearance 8 mm [m ²]	required clearance to meet ventilation requirements [in mm]
"100"	0,0112	19*	0,033	0
"90"	0,0104	21*	0,029	1
"80"	0,0096	23*	0,025	4
"70"	0,0082	27*	0,021	12*
"60"	0,0074	32*	0,018	31*

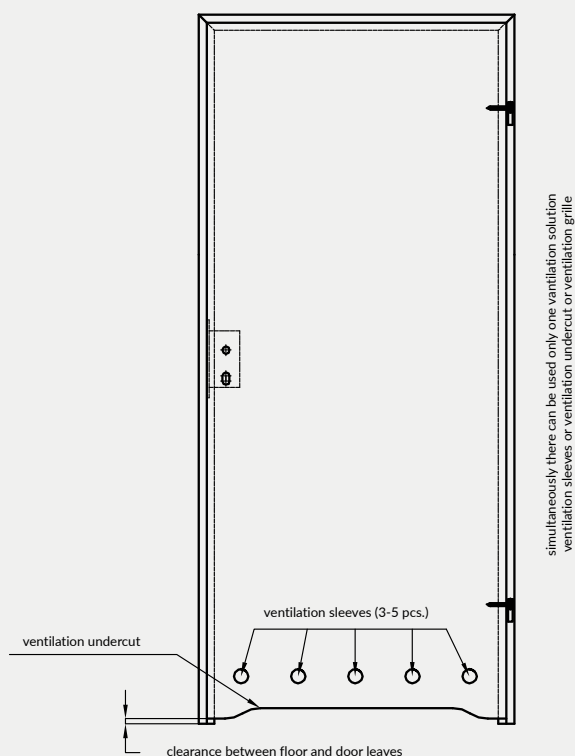

The above - stated required clearance height of the space under the door assures total ventilation surface of 0,022 m²
The standard clearance for door leaf is 8mm high.

* it is necessary to increase the clearance to the specified height by shortening door leaf at the bottom (when such a shortening is possible - see**)

** Exceptions that are not included in the table (door leaf that can not be shortened):





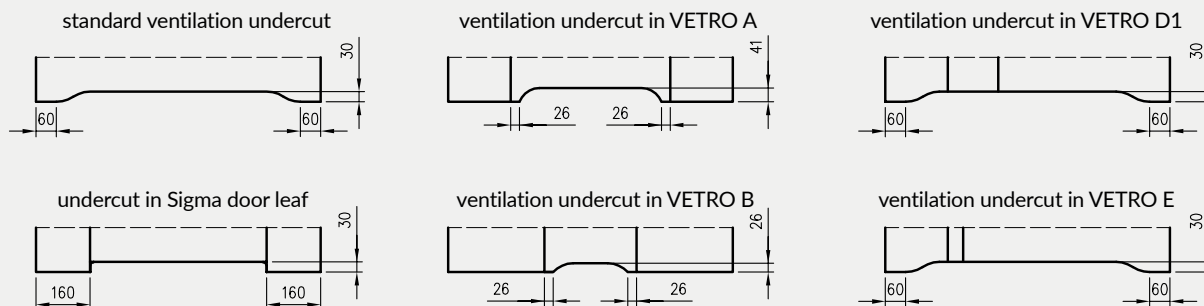

















- collection Vetro A, D and E - the use of ventilation undercut in the door with a width of "80" - "100" and a standard ground clearance of the door (8 mm) will fulfill ventilation requirements.
 - Vetro B collection - does not meet the ventilation requirements.
 - sliding door leaf - due to design of the sliding system (distance from the wall/tunnel - about 12 mm), door leaf meet ventilation requirement without need for additional options.
- there is no possibility to shorten double leaf doors and folding doors FOLDE.

VENTILATION UNDERCUT





GALLA 1 decormat, GALLA 2 sandblasted glass, transparent stripes

- | | |
|---|--|
|  panel doors , DRE - Cell veneer |  panel doors, laminate CPL |
|  frame construction doors, DRE - Cell veneer |  entrance doors, laminate CPL |
|  entrance doors, DRE - Cell veneer |  technical doors, laminate CPL |
|  technical doors, DRE - Cell veneer |  glass doors |
|  panel doors, 3D veneer |  panel doors Sara Eco 2 |
|  frame construction doors , 3D veneer |  smoke-proof technical doors |
|  entrance doors, 3D veneer |  fire resistant technical doors |
|  technical doors, 3D veneer |  anti-burglary doors |
|  panel doors, Finish foil |  panel construction doors, lacquered |
|  panel doors, painted |  panel construction doors, synchronous laminate |
|  frame construction doors, painted |  frame construction doors, synchronous laminate |
| |  frame construction doors, laminated |

Producer provides 24 months of warranty for door leaves and door frames.

pictures and visualisations used in the catalog present door leaf in the width of 80 cm (it doesnt refer to side panels). In the case of other door leaf widths, the proportions of the placement of the design of the collection, glazing, frames, millings, graphics will change. More technical informations and informations refered to assembly process are available in product guarantee card.

This product catalogue shall not constitute an offer under the regulations of the Civil Code and is published only for information purposes. Information provided in this catalogue was up-to-date on the day the catalogue was published. Due to the company policy of constant development DRE reserves the right to introduce (without prior notice) of changes to technical parameters, equipment, extended warranty conditions and product specification. The actual colours may vary from the colours printed in this catalogue. We reserve the right to errors in print.

Technical approvals:

- National Technical Assessment ITB-KOT-2019/0860 issue 1 (sliding system)
- National Technical Assessment ITB-KOT-2018/0633 release 2 (FORCA, ATHOS fire doors)
- National Technical Assessment ITB-KOT-2022/2051, edition 1 (glass door)
- National Technical Assessment ITB-KOT-2021/1945 edition 1 (folding and sliding glass doors)
- National Technical Assessment ITB-KOT-2017/0011 edition 2 (ENTER / SOLID / SOLID RC2)
- National Technical Assessment ITB-KOT-2018/0407 issue 1 (OLIMP)
- PN-EN 14351-2: 2018-E12 (interior doors)
- National Technical Assessment ITB-KOT-2019/1132 edition 1 (SARA door leaf)
- National Technical Assessment ITB-KOT-2019/0805 edition 1 (steel door frames)

DREwybór
architektów

DYSTRIBUTOR

DRE

82-300 Elbląg - Gronowo Górne, ul. Nefrytowa 4
Headquarters: phone 55 236 42 58
Customer service department: phone 55 236 42 43 to 48
fax 55 236 42 51
Marketing department: phone 55 236 42 40
working hours: 8:00 - 16:00
e-mail: dre@dre.pl, eksport@dre.pl www.dre.pl